



INSTALLATION, OPERATIONS & MAINTENANCE MANUAL

InspirAIR® ELITE

ENERGY RECOVERY VENTILATORS



FOR MODELS:

EK150-TQG, EK150-TF, EK150-TQX, EK150-TFX,
EK150-TQG-V5, EK150-TF-V5, EK150-TQX-V5, EK150-TFX-V5



"This product earned the ENERGY STAR® by meeting strict energy efficiency guidelines set by Natural Resources Canada and the US EPA. This product meets ENERGY STAR requirements only when used in Canada."

FOR EK150-TQG & EK150-TQX ONLY



Meets Standards:
C22.2 no 113 and
UL 1812

TO BE COMPLETED BY CONTRACTOR AFTER INSTALLATION

Installer: Leave this manual for the homeowner

Model

Installing Contractor

Telephone / Contact

Serial Number

Installation Date

REGISTER YOUR PRODUCT ONLINE AT ALDES-NA.COM

TABLE OF CONTENTS

I. INTRODUCTION 3

II. GENERAL ERV TERMINOLOGY AND FEATURES 3

- Definitions 3
- How Energy Recovery Ventilators Work 3
- Ventilation with an ERV 4

III. WARNINGS AND PRECAUTIONS 4

- Ducting Configurations 6
- Locating the Air Exchanger 9
- Type of Ducts to Be Installed 9
- Connecting the Ducts 9
- Vent Hood Locations 11
- Avoiding Condensation in your Unit 10
- Locating the Exhaust Air Grilles or Registers 12
- Locating the Supply Air Grilles or Diffusers 12
- Humidity Control 13

IV. INSTALLATION 13

- What's included 13
- Mounting the Unit 14
- Electrical Diagram 14
- Configuration Options 15
- Unit Wiring 17
- Wiring to the Power Source 19
- Installing the Digital Multi-Function Control (P/N 611242-FC) 19
- Digital Multi-Function Control Operation Modes 21
- Installing the 20/40/60 Minute Timer (P/N 611228) 21
- Installing the Speed Controller (P/N 611229) 22
- ZRT VentZone® System 22

V. MEASURING AND BALANCING AIRFLOW 24

- Measure and Balance 24
- Door-Port Balancing 24
- Balancing Airflow and Adjusting Motor Speed 26
- Door-Port Balancing Example 26

VI. MAINTENANCE 27

- General Maintenance 27
- Replacement Filters 28
- Technical Assistance 28
- Troubleshooting 29
- Service Parts for your ERV 31

VII. WARRANTY 32

- What's Included 32
- How to File a Warranty Claim 33

VIII. APPENDICE 33

- Appendice A. List of items (sold separately) for the installation of your ERV 33

I. INTRODUCTION

Thank you for purchasing a ventilation product from ALDES. To get the most out of your device, we recommend reading the user manual.

II. GENERAL ERV TERMINOLOGY AND FEATURES

Definitions

Energy Recovery Ventilator: An air exchanger is composed of two fans and a central module that allows the transfer of heat and humidity between the incoming and outgoing air of the ventilation system by providing a balanced supply of fresh air without mixing the two airflows.

How Energy Recovery Ventilators Work

The ALDES Energy Recovery Ventilator (ERV) brings in fresh air from outside. This air is distributed throughout the residence by a ventilation system or by the heating/air conditioning system. At the same time, the system draws in stale air (e.g., the kitchen, bathroom or laundry room) and allows the air to be expelled to the outside. In some systems, air may come from a heating/cooling system.

As the two airstreams cross in the core of the unit, the cool air is tempered by the heat recovered from the stale air. An ERV will transfer moisture from the outgoing air to the incoming air if the latter is drier, which improves the comfort of residents who may be bothered by the air that is too dry.

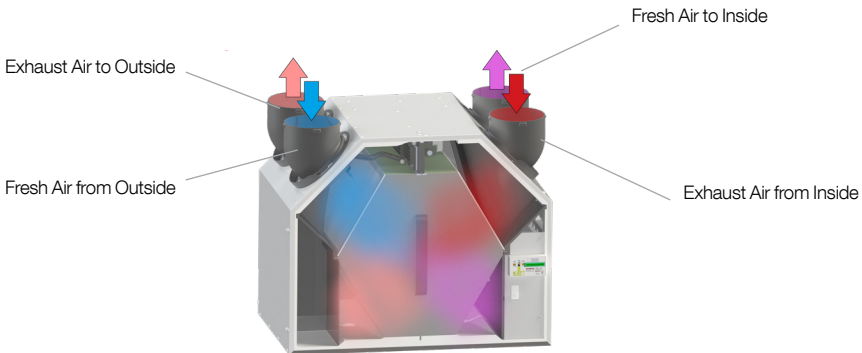

In summer, it's the other way around: the warm air outside is cooled by the cooler air generated by the air conditioning system, if the incoming air is more humid than the outgoing air, the ERV will transfer the moisture from one to the other. This reduces the dehumidification load on the air conditioning system. ERV reduces the continuous supply of moisture to the air in the home.

NOTE: It is important to understand that an ERV is not a dehumidifier, it can assist the air conditioning system by removing some of the moisture (water vapour) contained in the fresh air entering the home.

Ventilation With an ERV

In our modern homes, with the new insulation standards, it is necessary to have a supply of fresh air to maintain a healthy living environment inside your home. The ventilation rate required will depend on:

- The number of occupants and their level of activity
- The way your home was built
- Your preferences regarding the level of ventilation

ALDES ERVs create a fresh air supply by recovering part of the energy from the exhaust air. A properly installed, well used, and well-maintained ERV:

- Extracts stale air
- Recovers most of the energy from the exhaust air
- Uses the energy of the exhaust air to preheat or cool the air entering the house
- Distributes fresh air throughout the house

During the cold season or when the air conditioning is running, the ERV should be configured to operate continuously at low speeds with the ability to switch to high speed as required. For example, if a lot of people are present, you will need to temporarily put the device in high-speed mode. If your home is unoccupied for a long time, you can use an intermittent mode.

III. WARNINGS AND PRECAUTIONS

WARNING: Identifies a directive that, if not followed, may cause serious body injury or death.

CAUTION: Identifies a guideline that, if not followed, may cause serious damage to the device, its parts, or related components.

RECOMMENDATIONS and NOTES: The modes of operation, the installation of ventilation hoods, the diagram of the ventilation ducts, and the use of the equipment's advanced features can result in energy savings and improved comfort.

Installation and operation of these units must be in accordance with local building and safety codes.

WARNING!

To avoid the risk of injury or damage to your device, it is not recommended that you repair the electrical or mechanical components of your device yourself. The ERV must be installed and maintained by a CERTIFIED heating and cooling contractor.

CAUTION

Before installation, careful consideration must be given to how this system will operate if connected to any other piece of mechanical equipment like a forced-air central heating unit or a fan with a higher static pressure, for example. In such a case, the configuration of the network will be different. Once the installation is completed, balancing of the associated equipment and the ERV will be necessary, and this must be carried out according to the procedures described in this user manual.

NEVER install an ERV on a ventilation system that leaks air, is ill-suited to the appliance and may create negative pressure, or is ill-suited to the related appliances in the ventilation system.

WARNING

TO REDUCE THE RISK OF FIRE, ELECTRIC SHOCK OR INJURY, READ THE FOLLOWING:

1. This device must be used in accordance with the manufacturer's instructions. If you have any questions, please contact the manufacturer at the address or telephone number provided.
2. Before repairing or cleaning the unit, disconnect it from the power supply.
3. This unit is not designed to supply air to a combustion appliance.
4. This unit is not designed to supply make-up air to other exhaust appliances, such as range hoods, clothes dryers or other equipment exhausting stale air to the outside.
5. When renovating, always pay particular attention to electrical wiring or other services that may be concealed in walls or ceilings.
6. Do not use any controller other than that recommended by the manufacturer for speed, timers, humidity or other modes.
7. The unit must be earthed. The NEC terminal block provides a terminal for connecting the ground wire to the unit. The unit's ground wire must therefore be connected to the building's grounding system in accordance with the building code. Do not use extension cords.
8. Do not install an air intake near a range (see "**Locating the Exhaust Air Grilles or Registers**" on page 12). Do not connect to any other appliance.
9. Do not use to exhaust hazardous or explosive products.
10. When installing, servicing or cleaning the unit, wear safety glasses and gloves.
11. More restrictive local regulations take precedence over the information in this guide.

ATTENTION

1. This product is intended for residential use in accordance with the requirements of the International Residential Building and Mechanical Codes, NFPA 90B for the United States and the National Building Code of Canada.
2. It is recommended to turn the unit off during renovations to avoid clogging the filters and loading the fans with dust.
3. Refer to the product data sheet for dimensions, electrical requirements, drain connections, etc.
4. The exhaust air duct must discharge directly to the outside. It must not be redirected to an attic, crawl space or attached garage.

Ducting Configurations

The purpose of the indoor ventilation system is to remove stale air and replace it with fresh air. It is the installer's responsibility to ensure that all ducts are properly sized and installed, and that the system operates in accordance with established standards.

The airflow rate (CFM) that an ERV must deliver is directly related to the total static pressure (TSP) of the system. Static pressure is the measure of resistance obtained by sending a certain flow of air through a duct, the length of the duct in addition to the number of fittings used being taken into account in this calculation. The following pages describe 4 configurations of a ventilation system, from the most desirable to the least desirable.

Note: *These examples are valid for single- and multi-family homes. Other applications, such as greenhouses, atriums, swimming pools, saunas, etc., require a separate ventilation system that must be independent of the main system.*

Note: *The way your ERV is installed can make a considerable difference to the electrical energy you use. To reduce the ERV's electricity consumption, a fully ducted stand-alone installation is recommended. If you choose a simplified installation that operates your furnace's air handler for room-to-room ventilation, a low-power furnace with a variable-speed and electronically commutated fan motor will reduce your electrical energy consumption and operating costs.*

Fully Ducted System – Best Configuration

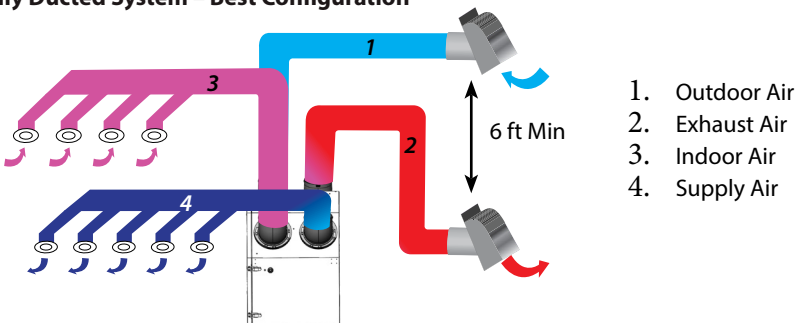

A **Fully Ducted System** is the most efficient configuration. It is particularly suitable for homes without central heating or air-conditioning systems. Exhaust grilles draw stale air from service rooms (bathrooms, laundry rooms and kitchens). Air grilles supply fresh air to main rooms and bedrooms; they should be installed on ceilings or at the top of walls. Installation of an air diffuser is recommended. Care should be taken when installing a floor grille. See “**Locating the Exhaust Air Grilles or Registers**” on page 12 and “**Locating the Air Grilles of Diffusers**” on page 12. See the installation instructions for these products (sold separately).

This system is not connected to an air handling unit or furnace. This system is normally balanced on high speed. If ALDES patented ZRT® are integrated into the ventilation system, airflow balancing should be performed at normal speed. *Refer to the ZRT brochure for more details on installing an ERV in the presence of ZRTs.*

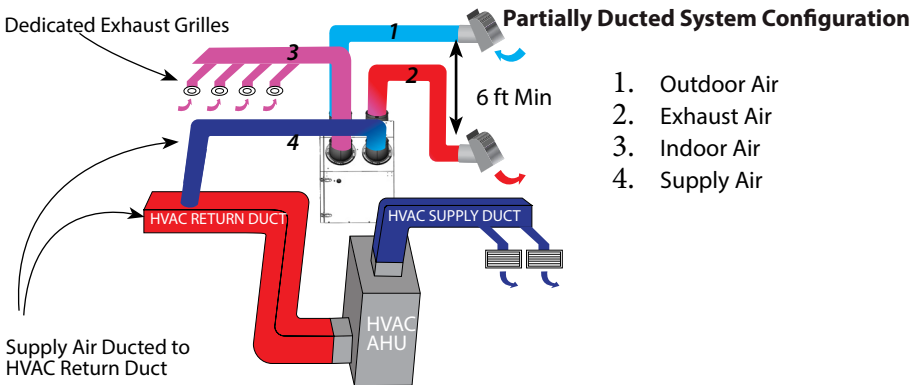

In a **partially ducted configuration**, ventilation grilles recover stale air from the various service rooms. Each air grille can be fitted with a timer system to manage high-speed ventilation. Fresh air is distributed by the centralized air handling unit (AHU) of the heating and air-conditioning system. Connection to the central ventilation system is usually made via the HVAC return duct. See section “**Interlocking the ERV to an Air-Handler/Furnace Blower**” on page 18. Although this configuration is common in commercial installations, it is not recommended for residential installations due to the following:

1. In this case, the AHU must operate continuously or be interlocked to operate with the ERV to avoid airflow variations.
2. If the AHU offers several speeds, the airflow balancing must be done with the most frequently used speed. If a change of speed is made, the ERV will no longer be in phase with the main unit.

Residential ERV

3. During the hot, humid season, continuous operation of the AHU can cause evaporation in the cooling tower, resulting in a loss of humidity control. If the AHU is not in phase with the ERV, this can lead to condensation in the supply system and ducts.
4. Running the AHU continuously can cause draft effects in winter.
5. A motorized damper can be integrated into the ERV to prevent air intake during the shutdown cycle, but should not be installed in the air outlet duct.

For these reasons, it may be preferable to avoid direct connection of the AHU return and use an Indirect Approach instead.

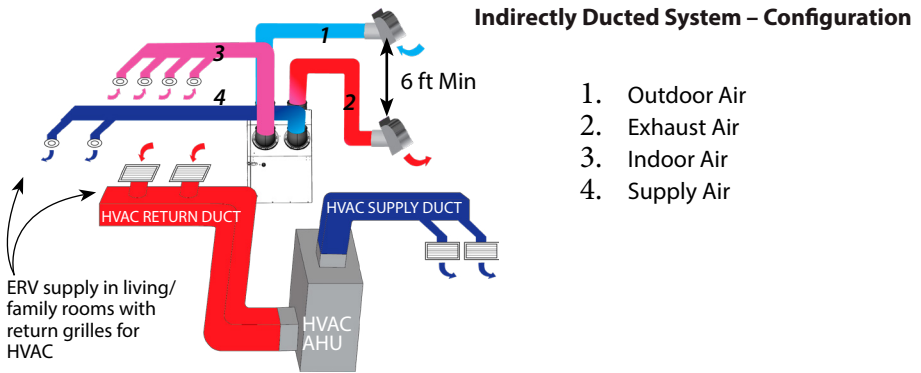

With this configuration, grilles discharge air from bathrooms, laundry rooms and kitchens. Fresh air is distributed to a large room with a large air volume, such as a family room, high staircase, etc. The forced-air system draws fresh air into the AHU's return grilles and redistributes it throughout the house. The ERV and AHU can operate independently, with no effect on airflow balancing. A ventilation-control thermostat is recommended to ensure air distribution outside heating/cooling cycles. Adding a timer to the system reduces energy costs, helps reduce the effects of drafts in winter and evaporation in the air-conditioning coil in summer.

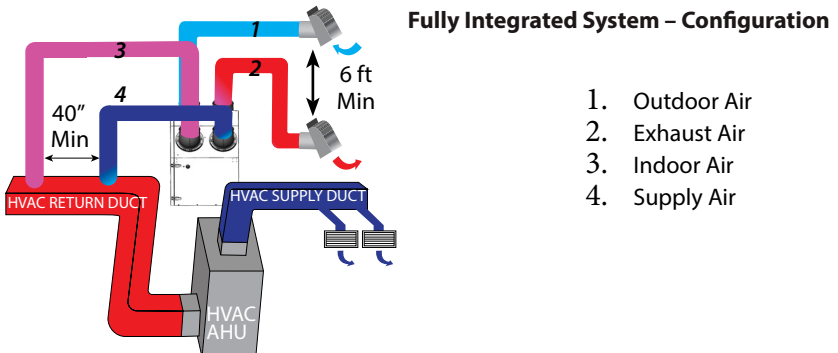

The **Fully Integrated System** extracts stale air from the return duct of the heating and cooling system and replenishes the upstream return duct with fresh outside air. A minimum distance of 40" (1 m) is recommended between connections. See "**Interconnecting the ERV and the forced-air heating/cooling system**" on page 18.

A fully integrated system is a very common installation in most climates. It is important to consider the following:

Airflow calibration may change if the AHU is switched on or off, depending on different speeds or heating and cooling cycles. It is recommended that this configuration be calibrated at high speed with the heating system switched on.

For optimum operation, the AHU should be switched on when the ERV is running. This prevents the air supply from short-circuiting the exhaust air outlet.

Motorized dampers can be integrated into the ERV to prevent fresh air from entering during the ERV shutdown cycle. Dampers in the air outlet duct are not recommended.

Locating the Air Exchanger

The unit must be installed in a temperature-controlled environment. Choose a central location in the house to reduce the distance air travels in ducts and the use of elbows. This helps optimize the ventilation system. The Aldes unit must be installed in such a way that it is easily accessible for maintenance, inspection, repair or other work on the unit.

Type of Ducts to Be Installed

IMPORTANT: Always validate the applicable building code before designing your ductwork. The building code takes precedence over the following recommendations.

1. When ducts are installed in a partitioned space (wall, ceiling or floor), they should be made of metal sheathing to offer the least possible resistance to airflow, and to make them easier to clean.
2. When ducts are easily accessible, we recommend using 5 to 10 feet of insulated flexible duct between the ERV and the air vent, to reduce ventilation noise in the home.

Connecting the Ducts

The InspirAIR Elite ERV family is designed to facilitate duct connection. Thanks to the unit's swivelling ports, it offers various connection possibilities (see image below).



Residential ERV

To ensure an optimal performance of the air exchanger, position the ducts so that they are as straight as possible. Ducts should be short and have no bends to maximize airflow. Forty-five-degree elbows are preferable to 90-degree elbows. Use “Y” rather than “T” joints wherever possible.

All ducts running through unheated areas should be insulated. Ducts between outside air outlets and the ERV must be insulated and covered with a vapour barrier. See **“Vent Hood Locations” on page 11**.

Flexible ducting is recommended to reduce vibration between the air exchanger and the ducts. Start by determining the length of ducting needed to reach each machine port, and cut it to the required length.

EK150 models feature swivel ports to simplify duct connection to the air exchanger. Remove each port from the unit by turning it to unlock it. Tape the ducts to the ports. Reinstall the ports, once connected to the ducts, to the ERV vents, aligning the locking marks while turning them clockwise.

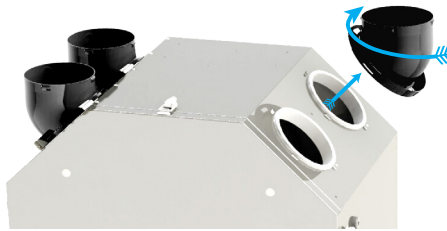

Avoiding Condensation in your Unit

1. Remove the insulation to expose the flexible conduit.
2. Secure the flexible conduit to the port with a tie wrap at the notches.
3. Pull the insulation over the joint and tuck it between the inner ring and the outer half-ring of the double port, then lower the vapour barrier to the bottom of the vent.
4. Tape the joint (outer half-ring, vapour control layer and sheet metal if necessary) to ensure an airtight seal. Avoid compressing the insulation when taping it firmly to the joint.

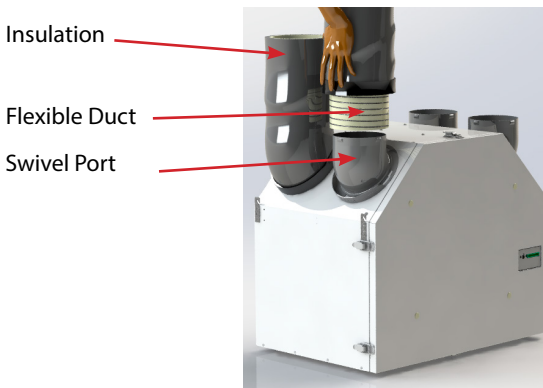

Vent Hood Locations

(Manufacturer's recommendation. Also consult your local building code).

Wall-mounted hoods (sold separately) must be installed where they are easily accessible for cleaning. Note: Please refer to wall hood installation instructions.

Fresh Air (Intake) Wall hoods:

- Must be located upstream (if there are prevailing winds) of the wall-mounted exhaust hood.
- At least 6 feet (2 metres) from the exhaust hood.
- At least 6 feet (2 metres) from dryer and furnace vents (medium- or high-efficiency).
- At least 6 feet (2 metres) from aisles, oil filler pipe, gas cylinder or waste bins.
- At least 18 inches (457 mm) above the ground or the height of average snow accumulation.
- At least 3 feet (1 m) from the corner of the building.
- Do not install in a garage, attic or crawl space.

Exhaust Air Wall hoods:

- At least 6 feet (2 metres) from the fresh air intake hood.
- At least 18 inches (457 mm) above the ground or the height of the average snow accumulation.
- At least 3 feet (1 metre) from the corner of the building.
- Should not be located near a gas meter, an electric meter or a driveway where fog or ice could make the driveway unsafe.
- Do not install in a garage, attic or crawl space.

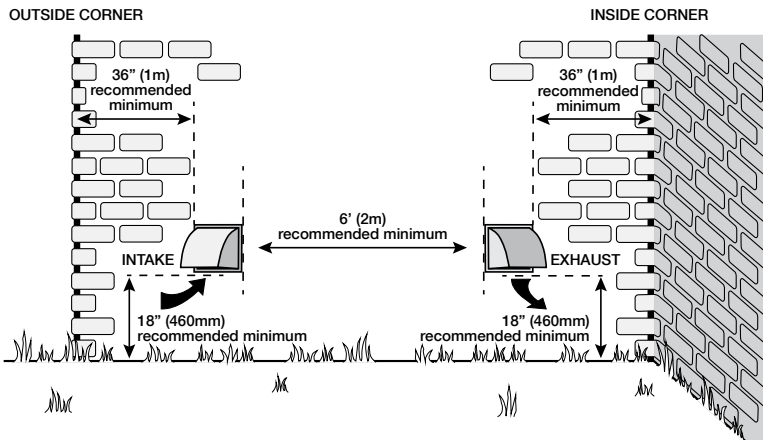

Note: Building codes may require or allow greater or lesser distances between the exhaust hood and the intake hood.

Locating the Exhaust Air Grilles or Registers

The air exchanger system must have at least one exhaust air register. Exhaust air registers should be installed in areas where humidity is highest, such as bathrooms, kitchens or laundry rooms, but not in steam showers, jacuzzi, indoor pools or solariums. Do not connect the cooker hood to the ERV. The cooker hood must be connected to an exhaust system independent of the air exchanger system. An additional 45-degree exclusion zone from the cooking area must be provided when designing the ventilation system.

Exhaust registers should be installed in strategic locations, such as on the second floor near the bathroom and kitchen, or near the bathroom on other floors. It is not recommended to install an exhaust register in a room where there is a combustion appliance such as a fireplace, furnace or wood-burning stove. Vent dampers should preferably be installed on the ceiling, otherwise within 12" (30 cm) of the ceiling on the wall.

Pivoting grilles can be used to control the flow. External accessories can be installed to calibrate the exhaust airflow rate. Grilles must not be adjusted after the unit has been calibrated.

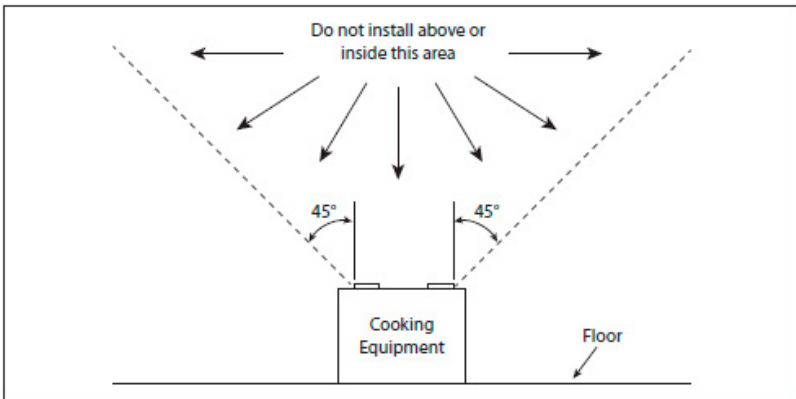

Locating the Supply Air Grilles or Diffusers

Fresh air diffusers should be installed in hallways, bedrooms and/or common rooms. They should be located at a reasonable distance from the exhaust registers to promote the circulation of fresh air throughout the house. Diffusers should be installed high up on the wall or ceiling. If the diffuser is located in a common area, it is recommended to install it on the ceiling so that the fresh air can better mix with the air already present in the room. This will improve your comfort in cold weather. If a diffuser is installed on the wall, place it within 12" (30 cm) of the ceiling.

Adjustable grilles or diffusers can be used to control airflow. Grilles or diffusers must not be adjusted after the unit has been calibrated.

Humidity Control

New, well-insulated and airtight homes trap a high level of humidity during the cold season. The presence of humidity in a house is easily visible by the presence of condensation on the windows. Window condensation will increase as the outside temperature cools.

Your ERV will help reduce indoor humidity levels by bringing dry air into the home and exhausting moist air to the outside. Condensation on windows generally occurs when the outside temperature is below 10°C, as shown in the following table:

RECOMMENDED RELATIVE HUMIDITY TO PREVENT INDOOR CONDENSATION*	
OUTSIDE AIR TEMPERATURE	RELATIVE HUMIDITY
0°C to 10°C (32°F to 50°F)	45% - 50%
-6°C to 0°C (21°F to 32°F)	40% - 45%
-12°C to -6°C (10°F to 21°F)	35% - 40%
-18°C to -12°C (0°F to 10°F)	25% - 30%
-24°C to -18°C (-11°F to 0°F)	20% - 25%
Under -24°C (-11°F)	Under 20%

ASHRAE 62.2 standards recommend maintaining a relative humidity rate between 30% and 60%. The average person is comfortable between 30 and 50% relative humidity (RH).

ALDES offers several wall controls with a dehumidistat function. Please refer to the wall control user guide for detailed information.

IV. INSTALLATION

What's Included

Verify that all parts have been included with the shipment. If any parts are missing, notify your distributor as soon as possible. **Note: Parts quantity may vary according to air exchanger model.**

- Energy Recovery Ventilator
- User manual
- Parts:
 - Springs (4)
 - Hooks (4)
 - Metal screws for hooks (8)
 - Wood screws for hooks (4)
 - Plastic tie (1)
 - Plugs (hides static pressure connection holes)(4)
 - Mounting chains

Certain items (sold separately) can be used to install your unit. Contact your local distributor to order ALDES items. **See Appendix 1 for a list of components.**

Residential ERV

Mounting the Unit

The air exchanger is designed to be suspended or installed on a wall bracket (sold separately, P/N 699921). To suspend the unit, screw the hooks at the top corners of the unit into the holes provided. Using chains and springs, hook the air exchanger chains to the ceiling joints.

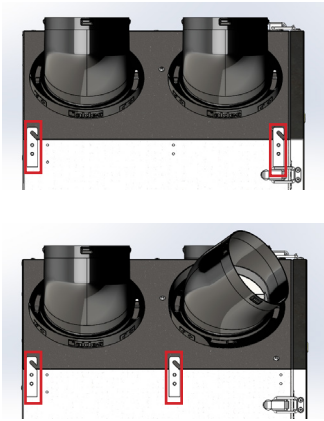

To facilitate installation, you have the option of putting the second hook on the centre holes to clear the duct for a special installation (duct in front position). See the images to the left of this text.

Note on the installation: To facilitate assembly of the unit, we recommend dividing the installation into two stages. First, install the unit without the recovery core. This makes it easier to handle when attaching the unit to the chains or wall bracket. Second, reinstall the recirculation core and close the unit door.

Electric Diagram

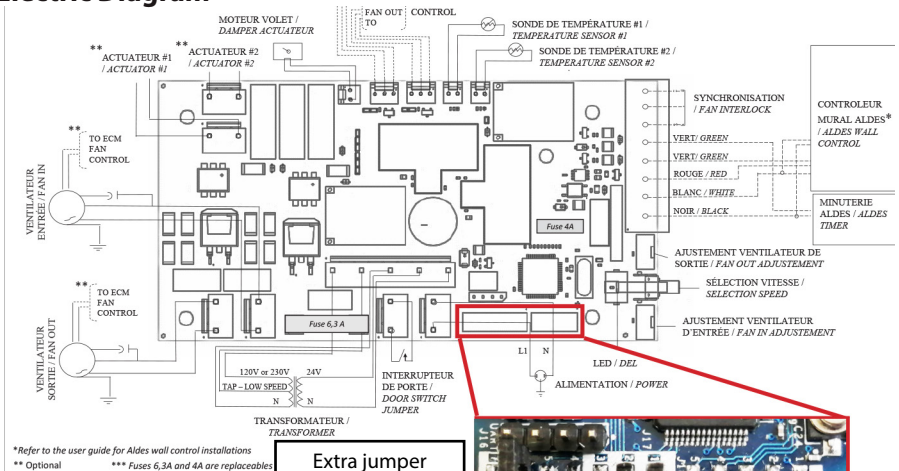

* Refer to the user guide for Aldes wall control installations
 ** Optional *** Fuses 6.3A and 4A are replaceables

Extra jumper (does not connect both pins).

Option is selected when jumper connects both pins on the row.

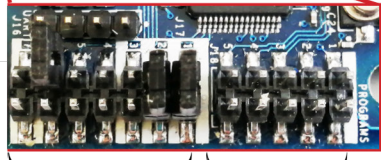

Options jumper block Programs jumper block

Configuration Options

In order to configure the different modes on your unit, you may need to move a jumper on the unit's printed circuit board. This can be done without any special tools following the directions below.

Suggestion: it is easiest to do this prior to installation, on a table with the unit on its back.

1. Disconnect the unit power cable to avoid electric shock or damaging the PCB.
2. Remove the unit's terminal block by pulling it towards you.



3. Slide out the electronic box from the unit, then use a Phillips-head screwdriver to remove the five screws holding the electronic control box together.
4. Once the screws have been removed, lift the electronic control box upwards to access the PCB. Locate the jumper pins on the PCB. They are located just behind the motor speed controllers, at the front of the unit.



5. In order to configure the different modes available for the unit, you will need to move different jumpers in the options terminal block. It is the block with jumpers pins ranging from 1 through 7. Below are the configurations for the different options available.

Residential ERV

5a) Defrost Modes

By default, the ERV is configured for **Normal Defrost**, with no jumpers on pin sets 5 and 6. Normal Defrost is optimized for most climate zones. The unit will automatically protect the core from frost build up by periodically switching to high-speed recirculation or exhaust.

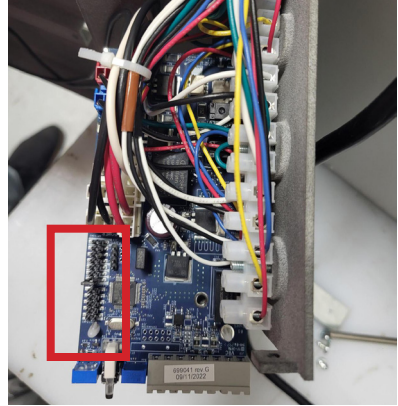

- For extremely cold climates, you can choose the **Extended Defrost** option which increases the time in which the unit stays in the defrost cycle. To activate the Extended Defrost option, position a jumper on the configuration port 6 and make sure it connects both pins in the row.

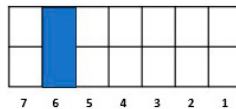

- The **Comfort Defrost** option prevents the ERV from switching from low to high speed and back during defrost cycles, so there will be no audible difference between exchange and defrost. To activate Comfort Defrost, position a jumper on the configuration port 5 and make sure it connects both pins in the row.

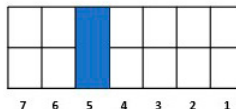

- **Note that the Extended and Comfort Defrost settings cannot be activated at the same time.** This means there should never be jumpers on both configuration ports 5 and 6.

5b) Relay mode

- In relay mode, an external device (e.g., air handler) or switch will determine when the ERV will operate.
- By default, the relay mode option is DISABLED.
- To activate relay mode, position a jumper on the configuration port 7 and make sure it connects both pins in the row.

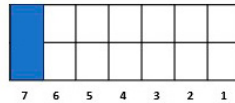

6. Once configuration is complete, replace the circuit board cover and the terminal block and proceed to wiring the unit to the controls.

Unit Wiring

A) Unit wiring to accessories

All units can be used with the following ALDES wall accessories:

- 611227: Electronic Humidistat with Liquid Crystal Display
- 611229: Speed Control
- 611230: Mode Control
- 611242-FC: Digital Multifunction Wall Control

These can all be used on their own or with a timer (611228).

To wire an accessory and/or a timer, connect the ERV as illustrated below.

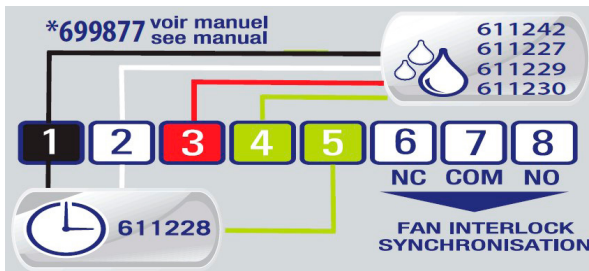

With this wiring, the unit can be operated at the following settings:

- Off
- Low-Speed Exchange
- High-Speed Exchange
- Low-Speed Recirculation
- High-Speed Recirculation

See **“Balancing Airflow and Adjusting Motor Speed”** on page 26 to alternate between low and high speeds.

B) Unit wiring for Relay Mode

In relay mode, an external device or controller will send a signal to indicate when the unit is to be activated. This is the case when using a VentZone® system or an external integrated controller. They will activate a third-party thermostat with integrated ERV controls, and external third-party switch to activate and deactivate the unit. Installations requiring a switch to activate or deactivate the unit should be in relay mode.

To activate the low-speed exchange mode, a connection must be made between terminals 1 and 3. If the connection is interrupted, the unit will go into standby mode. This connection can be made using a third-party switch or external controller, such as a smart controller with fan control and/or a programmable timer.

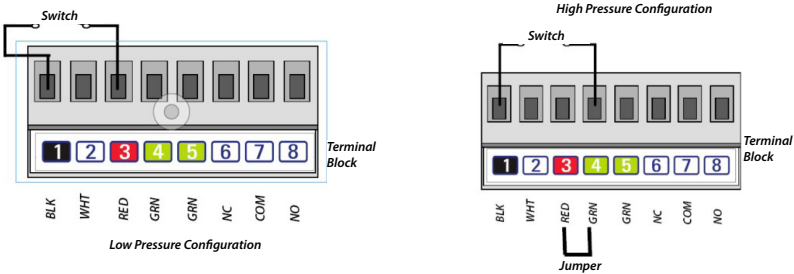

If low speed is insufficient and high speed is required to satisfy the ventilation rate, connect a jumper between terminals 3 and 4 in addition to the switched line between terminals 1 and 4 (see illustration above). This sets the ventilation speed to high.

C) Interlocking the ERV to an Air Handler/Furnace Blower

When the ERV shares its ductwork with a centralized heating/cooling system, the ERV can control the external fan to ensure that fresh air is properly distributed throughout the house. The unit's terminal block has two timing options via terminals 6, 7 and 8. Terminal 6 is NC (normally closed) and terminal 8 is NO (normally open). Terminal 7 is the common connection (COM) for terminals 6 and 8.

For the ERV to operate only in conjunction with the Air Handler/Furnace, do the following:

1. Connect the ERV as illustrated below. Refer to the AHU user manual and wiring diagram to create a relay connection to the ERV.

Note: It is the same process as connecting the fan control on a thermostat.

2. Ensure the air handler/furnace blower motor is operating whenever the ERV is in operation.

Note: Consideration must be given to competing airflows when connecting the ERV in conjunction with an Air Handler/Furnace Blower system.

Interconnection to a forced-air heating or cooling system (AHU)

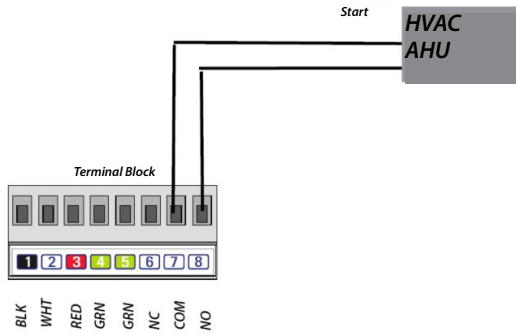

Wiring to the Power Source

Once all the ductwork is installed and the connections to the controllers are made, the ERV can be connected to a standard 120 V grounded outlet. The unit comes with a 3-foot electrical cord. A standard electrical outlet must be used.

DO NOT USE AN EXTENSION CORD. If additional wiring is required, have a licensed electrician make the electrical connection. A separate 15-amp, 120-volt circuit is recommended.

Installing the Digital Multifunction Control (P/N 611242-FC)

The Digital Multifunction Control (P/N 611242-FC) can be used with any type of ALDES Residential ERV. The controller should be installed in the place where excess humidity is most likely to be detected, for example near a bathroom, kitchen or in the basement. Ensure good air circulation around the controller. Do not place it behind a door, for example.



Please refer to the controller's documentation for detailed mounting and operating instructions. Note that the automatic dehumidistat mode is intended to be used when the outdoor air has less moisture content than the indoor air. Turn off the Automatic mode when outdoor air is hot and humid.

CAUTION: During the installation, turn off power to avoid risk of malfunction. To connect the Digital Multifunction Control to the ERV, follow these diagrams:

Note: Installation of a user-accessible control with your product model will improve comfort and may significantly reduce the product model's energy use.

Residential ERV

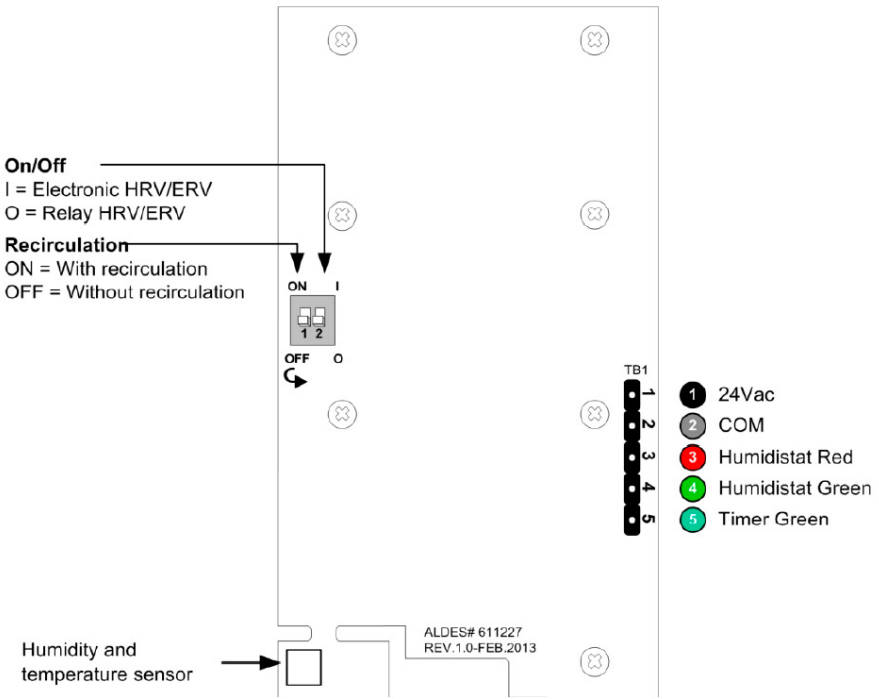













Set the ON/OFF switches to correspond to your ERV model, as listed in the following table:

	<p>With recirculation Models: EK150-TQG, EK150-TQX</p>
	<p>Without recirculation Models: EK150-TF, EK150-TFX</p>

Connect each wire to the terminal board on the back of the controller face plate according to the connection chart shown on the diagram. Then connect the 4-conductor wire to the terminal block on the ERV according to the respective colours. The control operates at 24 V. The table on the next page shows which operating modes are available for the different ON/OFF settings.

Digital Multi-Fuction Control Operation Modes

Mode	Speed	Description	 ON OFF 1 2	 ON OFF 1 2
OFF	-	Unit stops completely. Remains idle regardless of the humidity level.	Yes	Yes
		Remains idle until the humidity goes above the setpoint.	Yes	Yes
		Continuously exchanges air with the outside at low speed.	Yes	Yes
		Continuously exchanges air with the outside at high speed.	Yes	Yes
		Recirculates interior air at low speed.	Yes	n/a
		Recirculates interior air at high speed.	Yes	n/a
		Exchanges air with the outside at low speed for 20 minutes. Then remains idle for 40 minutes.	Yes	Yes
		Continuously exchanges air with the outside at low speed for 20 minutes. Then recirculates interior air at low speed for 40 minutes.	Yes	n/a

Installing the 20/40/60 Minute Timer (P/N 611228)

This controller provides the ventilation unit with high-speed exterior exchange for the following durations:

- 20 minutes
- 40 minutes
- 60 minutes

A service box is recommended when installing the timer switch.

1. Run a 3-conductor low-voltage (24 V) wire through the wall until it reaches the ERV.
2. Connect each wire to the timer switch according to its respective colour.
3. Connect the 3 wires to the ERV's terminal block according to their colours. Wires must be sized for 24 V.
4. Screw the backside of the control panel to the wall. Use the mounting screws to secure the top section into place.



Installing the Speed Control (P/N 611229)

This controller provides the ventilation unit with 4 modes of operation:

- Intermittent mode; successive cycles, low-speed 20 min exchange, 40 min stop mode or recirculation
- Low-speed exterior exchange mode
- High-speed exterior exchange mode
- Stop mode or recirculation (indicator lights are off)

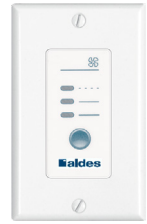

1. Run a 4-conductor low-voltage (24 V) electrical wire through the wall until it reaches the ERV.
2. Connect each wire to the control's terminal block according to its respective colour.
3. Connect the 4 wires to the ERV's terminal block according to their colours.
4. Screw the backside of the control panel to the wall. Use the mounting screws to secure the top section into place.

ZRT VentZone® Systems *

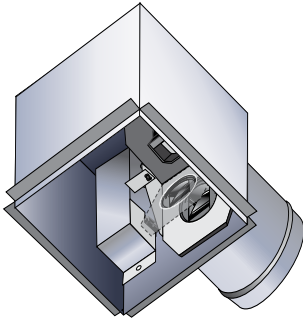

Each ZRT is fitted with a self-balancing constant airflow regulator that allows controlled amounts of continuous IAQ ventilation when the damper is closed. The primary flow damper opens when called upon by any switch, timer, dehumidistat, or occupancy sensor. Once the damper is opened, the ZRT signals the ERV or ERV to boost speed and airflow from the open ZRT, making it ideal for residential bathroom ventilation.

***Note: Only EKXX-V5 models are compatible with the VentZone system.**

Getting Started

Before installing your ventilator, the unit must be configured to operate in RELAY mode (see page 17).

Depending on the ZRT model, it may operate on either 120 V or 24 V supplied by the HRV/ERV. If you're not sure which you have, this can easily be determined by the colour of the ZRT wires. All ZRTs have one green wire (ground) and two red wires (switch). The other 2 wires are black (120 V) or yellow (24 V).

This installation must be done by a professional installer.

Installing the Ventilator

For installation details on your ERV, please refer to page 14 Section "Mounting the Unit."

Installing the Zone Register Terminal to the Ventilator

The VentZone assembly, supplied with 24 V ZRTs, is designed to operate with an ERV.

It is recommended to use the 20/40/60 timer (#611228) to avoid over-ventilating and/or damaging the air exchanger in cold climates, or creating frost in the ventilation system.

The basic VentZone® system is designed to provide continuous low-speed ventilation, with temporary high speed on demand via a ZRT.

To activate the low-speed mode, place a jumper on connections 1 and 3 of the ZRT.

Note: A switch can activate or deactivate ventilation without interfering with ZRT operation. This can be ideal at times of year when opening a window is possible, or when the house is empty for a long period of time, as it reduces power consumption.

Each ZRT will require its own timer. Connect as illustrated below.

VentZone® Zoned IAQ with Energy Recovery Kit

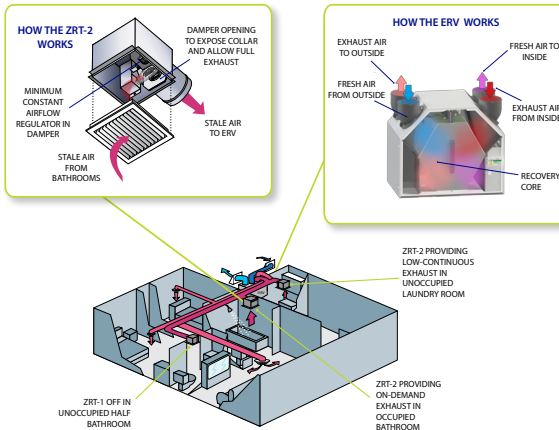

Note: the timer must be connected according to the colour codes on the terminal.

Adding Accessories to the VentZone® System

Due to the operation of the VentZone® System and wire connections, only the multifunction wall control can be used.

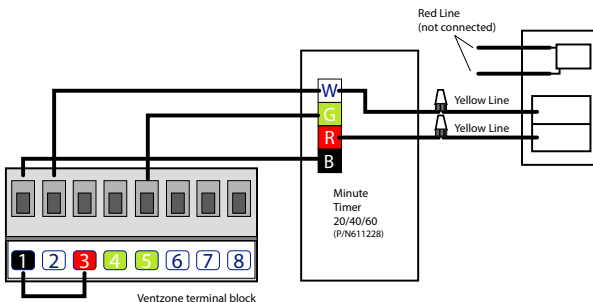

V. MEASURING & BALANCING AIRFLOW

Measure and Balance

The installer must measure and balance the airflow brought in from the outside and the exhaust airflow so that the difference between the two is less than 10% of the maximum airflow. This airflow balance is especially important in homes using a combustion device or in those located in areas where the ground emits radon.

If the airflows are not properly balanced, then:

- The ERV may not operate at its maximum efficiency
- A negative or positive air pressure situation may occur in the house
- The unit may not defrost properly

Excessive positive pressure may drive moist indoor air into the external walls of the building, where it may condense (in cold weather) and degrade structure components. It may also cause key holes to freeze up.

Excessive negative pressure may have several undesirable effects. In some geographic locations, soil gases such as methane and radon gas may be drawn into the home through the basement/ground contact areas. Excessive negative pressure may also cause the back drafting of vented combustion equipment.

CAREFULLY READ THE WARNINGS IN THE SECTION “WARNINGS AND PRECAUTIONS” ON PAGE 4, 5 AND 6. The flow of fresh and exhaust air can be measured and calibrated by two methods: via the door ports or via the ventilation ducts.

Door-Port Balancing

Door-port balancing is used to determine and adjust the airflow rates of the supply and exhaust air streams by measuring the static pressure loss across the ERV core. The recommended tool for this procedure is a differential pressure gauge (with a 0.0-0.25 in. w.g. range) or a digital manometer.

Note: The airflow chart on the door of the unit is for use with the filters that come with the unit. If other filters are used, in-duct measurements of airflow may be made using pitot tube, airflow probes, or hot-wire thermal anemometer as described in later sections.

Door-Port Balancing – Measuring Airflow

1. Finish the installation and sealing of the ERV and ductwork system.
2. Make sure all the ERV components are correctly installed and functioning properly.
3. Prepare the pressure gauge by mounting it according to the manufacturer's instructions and bringing the gauge back to zero.

4. Prepare the ERV and select the operating speed. For most installations, measuring at high speed permits a more accurate reading, and the system will normally remain balanced at lower speeds. For the VentZone system, balancing at low speed is recommended.
 - a. If there are dynamic elements in the duct that react to changing pressures, the ERV should be balanced at the speed it is expected to operate most of the time. Example: If the ducting system includes zone dampers or Zone Register Terminals (ZRT®), it must be balanced at a speed lower than normal operation. If balanced at high speed, the ERV will not be in balance at the lower speeds due to the operation of the constant airflow regulators incorporated in the ZRTs.
5. If the ERV is ducted to the forced-air HVAC system, the blower must be on high speed as well.
6. Airflows in branch lines to specific areas of the house should be adjusted first prior to balancing the unit. A smoke pencil used at the grilles is a good indicator of each branch line's relative airflow.
7. Locate the 4 ports on the door of the ERV and remove the plastic caps.
8. Refer to the drawings below and connect the tubing from the pressure gauge to the respective door ports to the outdoor air and supply air ports.

Note: system operation may differ from one model to another.

9. Record the pressure measurement on the balancing chart.
10. Refer to the balancing chart on the unit. It shows the pressure readings versus the corresponding supply airflows. Record the airflow you just measured on the chart.
11. Connect the tubing to the corresponding indoor air and exhaust air door ports using the diagram below.
12. Repeat steps 6-8 for the exhaust airflow.
13. Then follow the procedure in the following section.

Note: Generally, the best performance of the ERV is achieved when the airflows are within 10% of each other. The airflow balance may be set for balanced airflow, slightly positive or slightly negative, depending on the particular needs of the home. Often a slight positive pressure is desired to help resist back draft from combustion devices, radon gas, or drawing air from an attached garage.

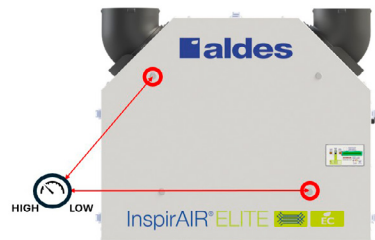
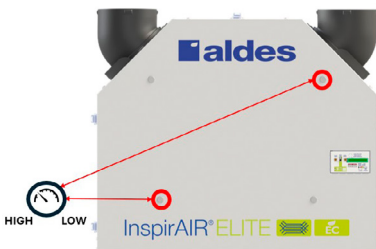

Residential ERV

Balancing Airflow and Adjusting Motor Speed – FLEXControl User Interface

The FlexControl allows the independent control of speed between the two fans.

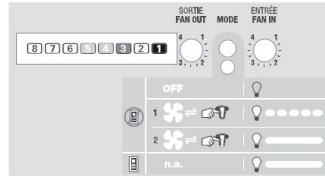
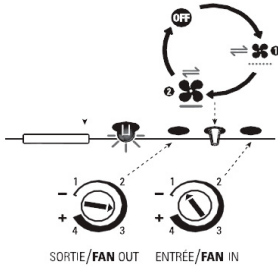

Detail of the potentiometers on the ERV

1. To adjust SUPPLY (FAN IN) airstream: Connect the tubes like the diagram above shows, then turn the FAN IN potentiometer to the desired level.
2. Adjust the EXHAUST (FAN OUT) airstream: Connect the tubes like the diagram above shows, then turn the FAN OUT potentiometer to the desired level.
3. Repeat the airflow measurement and adjustment until the desired supply and exhaust airflows are obtained.
4. Remove all tubing and replace the plugs in the door ports.

Door-Port Balancing Example

The balancing chart shown below shows an example of the relation between pressure drop through the core and the associated CFM. The chart presented on your unit should be used to establish the designed amount at CFM.

Model no : EK150-TQG		# Série / Serial : Date :	
Pression / Pressure Pa inH2O		Débit / Flow Frais / Fresh Vicié / Stale PCM / CFM PCM / CFM	
25,0	0,10	39	
27,5	0,11	42	39
30,0	0,12	44	43
32,5	0,13	47	46
35,0	0,14	50	49
37,5	0,15	53	52
40,0	0,16	55	56
42,5	0,17	58	59
45,0	0,18	60	62
47,5	0,19	63	65
50,0	0,20	65	68
55,0	0,22	70	74
60,0	0,24	74	80
65,0	0,26	78	86
70,0	0,28	83	92

Note: This balancing chart is for informational use only. Do not use it to balance your unit.

VI. MAINTENANCE

WARNING: In order to prevent electric shock when cleaning or servicing, disconnect the ERV before servicing.

Homeowners: It may be preferable to have a qualified service technician complete your ERV general maintenance.



General Maintenance

WARNING: ALWAYS DISCONNECT THE DEVICE BEFORE PERFORMING MAINTENANCE

To access internal components: Remove or lift up the unit door. Remove the unit door by opening the latch and removing the door off the hinges.

1. Air Filters

- a. Securely disconnect the connector from the unit.
- b. With the door removed, remove the filters.
- c. Follow the cleaning schedule and procedure for your unit’s filter type.
- d. See the table below to determine the filter that comes standard with your unit and what replacement filter options are available from ALDES.

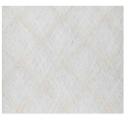
FILTER TYPE		
MERV 6	MERV 8	MERV 13*
		
USE: Trap impurities	USE: Trap impurities	USE: Trap impurities, pollutants and pollen.
CARE: Clean seasonally with water and detergent spray	CARE: Clean seasonally with water and detergent spray	CARE: Replace each season

*High-Efficiency Equivalent

2. Recovery Core

- a. With the door removed, remove the filters. Then remove the recovery core by gently pulling on the core handle. The core is fitted with a rail which allows it to slide smoothly into the grooves of the EPS casing. Wear gloves to protect your hands.
- b. Follow the cleaning procedure for your unit’s core type. **Warning:** take care when opening or removing the unit’s door in case the core was not securely installed previously and could fall out.

RECOVERY CORE TYPE
HIGH-EFFICIENCY POLYMERIC MEMBRANE COUNTER-FLOW ERV
Use a damp cloth to gently clean core. Do not drench or submerge the core in water.

Residential ERV

3. Cabinet (twice a year)
With the door removed, wipe down the inside of the cabinet with a damp cloth to remove any dust or debris. **ONLY USE WATER. DO NOT USE PRODUCTS CONTAINING SOLVENTS. DO NOT USE HOUSEHOLD CLEANING PRODUCTS.** Wipe the interior with a dry cloth.
5. Duct Work (as needed)
The ductwork running to and from the ERV may accumulate dirt. Wipe and vacuum the ductwork once every year. It is recommended to contact a company that specializes in duct cleaning.
6. Exterior Wall Hoods
If exterior hoods are in an accessible location, make sure they are not restricted by patio furniture, plants, snow or other obstructions. All ductwork should be cleaned every 3 years.
7. Motors and fans (No maintenance needed)

After Performing Maintenance: Slide the core and filters back into the unit. Re-attach the door to the unit and close the latches. Reconnect the unit and confirm proper operation.

Replacement Filters

Part Number (P/N)	Filter Type	Applicable Units	# of filters included in P/N order	# of filters needed in InspirAIR® Elite unit
699771	MERV 6*	InspirAIR ELITE	1	2
699772	MERV 8	InspirAIR ELITE	1	2
699881	MERV 13	InspirAIR ELITE	1	2

* Filter type is standard with unit

Technical Assistance

Canada call 1-800-262-0916 / Monday-Friday, 8 a.m. to 5 p.m. Eastern Time.

USA call 1-800-255-7749 / Monday-Friday, 8 a.m. to 5 p.m. Eastern Time.

ENERGY STAR® product (EK150-TQG ET EK150-TQX MODELS ONLY) :

This product is ENERGY STAR® qualified because it meets stringent energy efficiency requirements established by Natural Resources Canada and the U.S. EPA. It is ENERGY STAR qualified only when used in Canada. The following guidelines are recommended to ensure maximum efficiency when using this product.

Energy use:

The way your HRV/ERV is installed can make a considerable difference to the electrical energy you use. To reduce HRV/ERV electrical consumption, a fully ducted, self-contained installation is recommended. If you choose a simplified installation that operates your furnace's air handler for room-to-room ventilation, a low-power furnace with a variable-speed, electronically commutated fan motor will reduce your electrical energy consumption and operating costs.

Installing a user-accessible control on the product model enhances comfort and could considerably reduce the product's energy consumption.

Sound attenuation :

To ensure quiet operation of ENERGY STAR certified HRV/ERVs, each product model must be installed with appropriate sound attenuation techniques. For details on proper unit installation, see the Installation, Operation & Maintenance Manual.

TROUBLESHOOTING

<i>Symptom</i>	<i>Possible Causes</i>	<i>Solution</i>
The ERV does not power up (indicator light on the unit is not lit up)	<ul style="list-style-type: none"> Unit is not plugged in No power to outlet Defective fuse control board may be defective 	<ul style="list-style-type: none"> Make sure unit is plugged in Test outlet with another device
The ERV isn't communicating with the wall controller	<ul style="list-style-type: none"> Wall control is set to OFF. Terminal block is loose. Bad low-voltage connection or interruption (due to a nail in the wall, for example). 	<ul style="list-style-type: none"> Ensure that the wall control has power (screen or LED lights illuminate). Check wiring from ERV to wall control for open/short circuit. Ensure that the terminal block is well seated in the ERV
The ERV is producing excessive vibrations	<ul style="list-style-type: none"> Dirt on the fan wheels Malfunctioning motor 	<ul style="list-style-type: none"> Call contractor to perform ERV servicing
Poor airflow	<ul style="list-style-type: none"> Hoods or grilles are obstructed The ERV filters are clogged Obstruction in the energy-recovery core Poor power supply Ductwork is restricting airflow to/from ERV Speed is set to Low ERV is not balanced. 	<ul style="list-style-type: none"> Ensure that the outdoor exhaust and intake hoods are free of obstructions Clean or replace the filters Clean the energy-recovery core Use wall control to increase the speed of the ERV Call your contractor to check supply voltage and/or balance the airflows.
Supply air feels cold	<ul style="list-style-type: none"> Outdoor temperature is extremely cold. Supply grille is located close to occupants ERV automatic defrost function is not working Unit is in free cooling mode 	<ul style="list-style-type: none"> Locate the supply grilles high on the walls, or in the ceiling with a diffuser. Reduce the operating speed of the ERV If supply air is ducted through the furnace plenum, ensure that the ERV and furnace fans are interlocked. Disable free cooling (see page 24 or refer to the 611242-FC wall control user guide).
Wall Dehumidistat is not working	<ul style="list-style-type: none"> The wall control is not set properly Outdoor RH is higher than the control setpoint Bad low-voltage connection or interruption (due to a nail in the wall, for example). 	<ul style="list-style-type: none"> For control 611242-FC, ensure that the AUTO mode is selected and the target RH level is below the outdoor RH. For control 611227, ensure the wall control is not OFF and that the target RH setpoint is below the outdoor RH. Check wiring from ERV to wall control for open/short circuit.

Residential ERV

Symptom	Possible Causes	Solution
Indoor air is too dry (note: an ERV is not a dehumidifier, however, by exchanging indoor air with outdoor air, it can reduce excess indoor humidity if the outdoor air is drier).	<ul style="list-style-type: none"> • Dehumidistat wall control is set too low • ERV operating speed is too high • Improperly balanced ERV. 	<ul style="list-style-type: none"> • Increase setpoint of the dehumidistat • Operate ERV at low speed • Call a contractor to balance the ERV airflows • Add moisture to air with a humidifier.
Indoor air is too humid and/or condensation is forming on the inside of windows	<ul style="list-style-type: none"> • Dehumidistat is set too high • Obstructed supply or exhaust grilles • Not enough exhaust capacity near the source of moisture • ERV operating speed is too low. 	<ul style="list-style-type: none"> • Decrease the setpoint of the dehumidistat • Reduce sources of indoor humidity (steam, wet clothes, plants, firewood) and excessive temperature • Operate ERV at high speed or use continuous ventilation (not intermittent or ECO modes).
Frost is forming on the ERV and/or ducts connected to the ERV	<ul style="list-style-type: none"> • ERV is not balanced • ERV automatic defrost function is not working • Leaky vapour barrier around insulated duct • Hole in flexible duct. 	<ul style="list-style-type: none"> • Tape and seal all joints and duct connections • Repair any holes in flexible duct • Call contractor to balance the ERV and verify defrost functionality.
Water is accumulating in the bottom of the ERV	<ul style="list-style-type: none"> • ERV is not levelled. 	<ul style="list-style-type: none"> • Adjust the bracket so that the ERV is levelled.
ERV stays in high speed after the 20/40/60 minute timer cycle is complete	<ul style="list-style-type: none"> • One or more extraction ZRT dampers remains open • Timer in another bathroom is still active • Dehumidistat detected excess humidity while timer was on • Automatic defrost cycle is running based on cold outdoor temperature. 	<ul style="list-style-type: none"> • Check if wall control is set to a high-speed mode (dehumidistat, high-occupancy, etc.) • Check the bathroom exhaust terminals to ensure that the dampers are fully closed. • Wait a maximum of 30 minutes for defrost cycle to complete.

Service Parts for your ERV

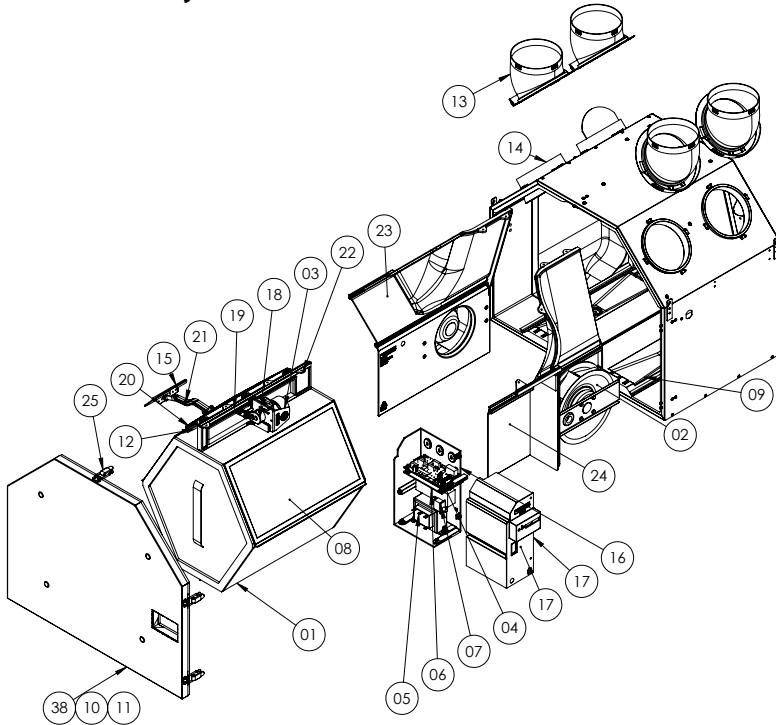

No.	P/N	DESCRIPTION	QTY
1	699764	ERV CORE	1
2	699765 or 699054	PSC MOTOR (TQG/TF VERSIONS ONLY) or EC MOTOR (TQX/TFX VERSIONS ONLY)	2
3	606398	SERVOMOTOR (TQG/TQX VERSIONS ONLY)	1
4	699039 or 699041	PCB FOR PSC MOTOR (TQG/TF VERSIONS ONLY) or PCB FOR EC MOTOR (TQX/TFX VERSIONS ONLY)	1
5	602212 or 602155	TRANSFORMER FOR PSC MOTOR (TQG/TF VERSIONS ONLY) or TRANSFORMER FOR EC MOTOR (TQX/TFX VERSIONS ONLY)	1
6	661039	CAPACITOR (FOR TQG/TF VERSIONS ONLY)	2
7	602052	INTERRUPTER	1
8	699771	FILTERS MERV6	2
9	699767	EPS CASING	1
10	699768	EPS DOOR	1
11	699769	FOAM FOR THE DOOR	1
12	699770	FOAM FOR THE RECIRCULATION (FOR TQG/TQX VERSIONS ONLY)	1
13	699761	5" EXTERNAL DUCT PORTS	4
14	604056	5" INTERNAL DUCT PORTS	2

Residential ERV

#	P/N	DESCRIPTION	QTY
15	699860	5" DAMPER	2
16	699763	ELECTRICAL BOX CASING PART1	1
17	699762	ELECTRICAL BOX CASING PART2	1
18	699757	PLASTIC ARM FOR SERVOMOTOR (TQG/TQX VERSIONS ONLY)	1
19	699758	PLASTIC DOUBLE ARM (TQG/TQX VERSIONS ONLY)	1
20	699759	RECIRCULATION DOOR (TQG/TQX VERSIONS ONLY)	1
21	699760	PLASTIC LONG ARM (TQG/TQX VERSIONS ONLY)	1
22	699756	FAN DEFROST SYSTEM (TF/TFX VERSIONS ONLY)	1
23	699755	PLASTIC SUPPORT - LEFT SIDE	1
24	699754	PLASTIC SUPPORT - RIGHT SIDE	1
25	609643	LATCH	6

VII. WARRANTY

What's Included

The warranty period for residential ventilation units begins on the date of manufacture indicated on the serial number (modelYYMMXXX where YY is the year and MM the month).

The Heat Exchanger has a warranty which is dependent upon its core type:

CORE TYPE	WARRANTY
High-efficiency polymeric membrane counter-flow ERV	Limited 5-year
ALL OTHER COVERED COMPONENTS	
Limited 5-year	

The Seller warrants to the Purchaser that any equipment manufactured by it and bearing its name plate, to be free from defects in material and workmanship, under proper and normal use and service as follows. If, at any time within the warranty of the product (see individual specifications), the Purchaser notifies the Seller that, in his opinion, the equipment is defective, and returns the equipment to the Seller's originating factory (via prepaid postage), and the Seller's inspection finds the equipment to be defective in material or workmanship; the Seller will promptly correct it by either (at its discretion): repairing any defective part or material or replacing it free of charge and returning the product to the purchaser via shipping (using the lowest cost prepaid transportation option). If the Purchaser requests premium transportation, the Purchaser will be billed for difference in transportation costs. If the inspection by the Seller does not disclose any defect in material or workmanship, the Seller's regular charges will apply. This warranty shall be effective only if use and maintenance is in accordance with our instructions and written notice of a defect is given to the Seller within such period. This warranty is exclusive and is in lieu of any other warranties, oral or implied, specifically, without limitation, there is no warranty of merchantability or fitness for any purpose. The liability of the Seller is limited to the repair or replacement of materials or parts as set forth.

Limitation of Liability: The Seller shall not be liable for any claim or consequential or special loss or damage arising or alleged to have arisen from any delay in delivery or malfunction or failure of the equipment. The Seller’s liability for any other loss or damage arising out of or connected with the manufacture or use of the equipment sold, including damage due to negligence, shall not in any event exceed the price of the equipment supplied by Seller.

How to File a Warranty Claim

Before removing a defective product, contact ALDES for technical assistance.

If a part is proved defective, it will be replaced with another part or repaired according to the company’s assessment.

Before returning a defective product for repair, contact ALDES customer service to obtain a Return Materials Authorization (RMA). Send the defective part postage paid to the address below based on your residence. It will be returned to you postage paid.

VIII. APPENDICE

Appendix A. List of items (sold separatly) for a standard installation.

- Wall bracket for InspirAIR® Elite units (P/N 699921)
- Digital Multifunction Controller (P/N 611242-FC) (required to enable free cooling)
- Electronic humidistat with LCD (P/N 611227)
- 20/40/60 Minute Timer (P/N 611228)
- Speed Control (P/N 611229)
- Mode Control (P/N 611230)
- Interior exhaust grilles
- Supply diffusers Sleeves or register boxes for interior supply and exhaust
- Exterior wall hoods for supply and exhaust
- Insulated duct
- Uninsulated duct
- MR Modulo - constant airflow regulators

NOTES

Date of Purchase _____

Retailer _____

*Keep receipt as proof of purchase

MAINTENANCE PERFORMED	DATE



American ALDES Ventilation Corporation
4521 19th St. Ct. E.
Suite 104
Bradenton, FL 34203
1-800-255-7749
www.ALDES-na.com

ALDES Canada
100 Rue Carter
Saint-Leonard d'Aston, QC J0C 1M0
1-800-262-0916
www.ALDES-na.com