



**MULTI-FAMILY HEAT AND ENERGY  
RECOVERY SOLUTIONS**

---



**INSPIRAIR® COMPACT**

---

**TECHNICAL RESIDENTIAL DOCUMENTATION**

## CONTENTS

INSPIRAIR® COMPACT: 80 MODELS.....	P 3
80 MODELS DIMENSIONS.....	P 4
80 MODELS PERFORMANCE.....	P 5
INSPIRAIR® COMPACT: 130 MODELS.....	P 7
130 MODELS DIMENSIONS.....	P 8
130 MODELS PERFORMANCE.....	P 9
INSTALLATION.....	P 10
APPLICATION.....	P 11
ACCESSORIES.....	P 14

**HIGH-PROFILE** PERFORMANCE **&** **LOW-PROFILE** DESIGN



E80-HRX

Small spaces demand smart technology. ALDES InspirAIR® Compact Heat and Energy Recovery Ventilators (HRV/ERV) fit neatly into condos, apartments, and other multi-family dwellings. These units improve indoor comfort and reduce the building's energy use.

InspirAIR® E80-HRX-N features an EC Motor that saves up to 35% on electricity, compared to PSC Motors, and delivers 20% more airflow capacity.

### PRODUCT DETAILS

- Rated for 73 CFM (H80-HF-N) and 74 CFM (E80-HF-N and E80-HRG-N) and 89 CFM (E80-HRX-N) at 0.2 in. w.g.
- Durable polypropylene core (H80-HF-N) or high-latent-transfer enthalpy core (E80-HF-N, E80-HRG-N, and E80-HRX-N).
- Horizontal configuration for flexible installation.
- Up to 73% sensible recovery efficiency (E80-HF-N, E80-HRG-N, and E80-HRX-N), a great choice for LEED-certified buildings.
- Hassle-free balancing using the balancing chart, pressure taps in the door, and the independently adjustable supply and exhaust blowers.
- Pressure-neutral cold climate frost protection using warm recirculated air (E80-HRG-N + E80-HRX-N).
- Unique compact door allows easy access to the washable MERV 6 filters (other filter options available).
- All models are HVI Certified and ETL Safety Listed.

### KEY FEATURES

- Exclusive free cooling economizer mode reduces the need for air conditioning in the spring and fall (E80-HRG-N + E80-HRX-N).
- Compact size (9" tall) permits installation in tight spaces.
- FLEXControl electronically balances airflow circuits for simple, accurate installation.
- No drain required with ALDES's high-latent-transfer HLT crossflow ERV technology.

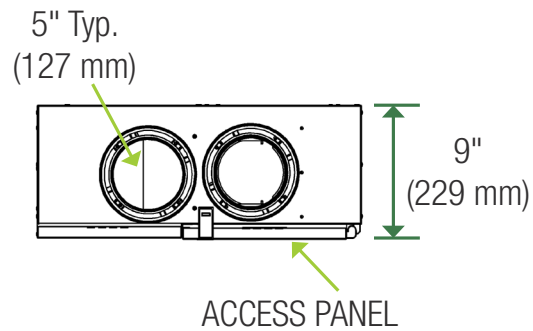
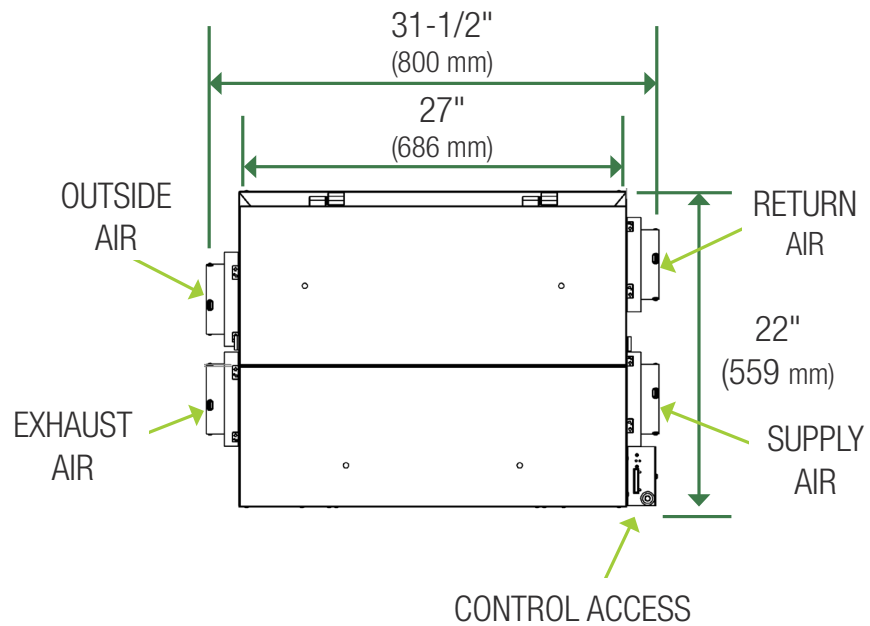
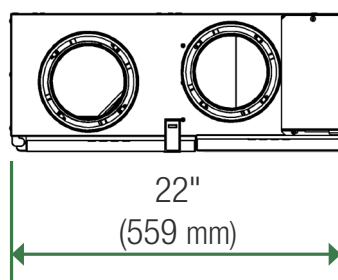

**DIMENSIONS****Side View (Left)****Bottom View****Side View (Right)**

PERFORMANCE

HVI CERTIFIED RECOVERY PERFORMANCE

MODEL	H80-HF-N			E80-HF-N				E80-HRG-N				E80-HRX-N					
Outside Air Temp.	Heating			Heating		Cooling	Heating			Cooling	Heating			Cooling			
	32°F (0°C)			32°F (0°C)		95°F (35°C)	32°F (0°C)		-13°F (-25°C)	95°F (35°C)	32°F (0°C)		-13°F (-25°C)	95°F (35°C)			
CFM (L/s)	56 (26)	65 (30)	80 (38)	55 (26)	67 (32)	80 (38)	49 (23)	50 (24)	64 (30)	81 (38)	54 (25)	49 (23)	50 (24)	64 (30)	81 (38)	54 (25)	50 (24)
Sensible Recovery Efficiency	70%	67%	64%	73%	70%	68%	--	73%	70%	68%	62%	--	75%	71%	69%	60%	--
Apparent Sensible Effectiveness	76%	74%	72%	80%	78%	76%	74%	81%	79%	77%	78%	74%	78%	75%	73%	62%	63%
Latent Recovery/Moisture Transfer	--	--	--	61%	59%	55%	66%	63%	60%	58%	64%	66%	69%	66%	63%	64%	58%
Total Recovery Efficiency	--	--	--	--	--	--	64%	--	--	--	--	65%	--	--	--	--	61%

FREE COOLING ECONOMIZER MODE SPECIFICATIONS

Model	Bypass Damper	Temperature Indoor		Temperature Outdoor		Net Airflow in Free Cooling Economizer Mode (CFM at 0.4 in. w.g)			
						High Speed		Low Speed	
		°F	°C	°F	°C	CFM	L/s	CFM	L/s
E80-HRG-N	Open - Starts Free Cooling	> 72°	> 22°	> 55° OR < 66°	> 13° OR < 19°	80	38	49	23
	Close - Starts Heat Recovery	< 72°	< 22°	< 55° OR > 66°	< 13° OR > 19°	--	--	--	--
E80-HRX-N	Open - Starts Free Cooling	> 72°	> 22°	> 55° OR < 66°	> 13° OR < 19°	84	40	49	23
	Close - Starts Heat Recovery	< 72°	> 22°	< 55° OR > 66°	< 13° OR > 19°	--	--	--	--

### VENTILATION PERFORMANCE: 80 MODELS

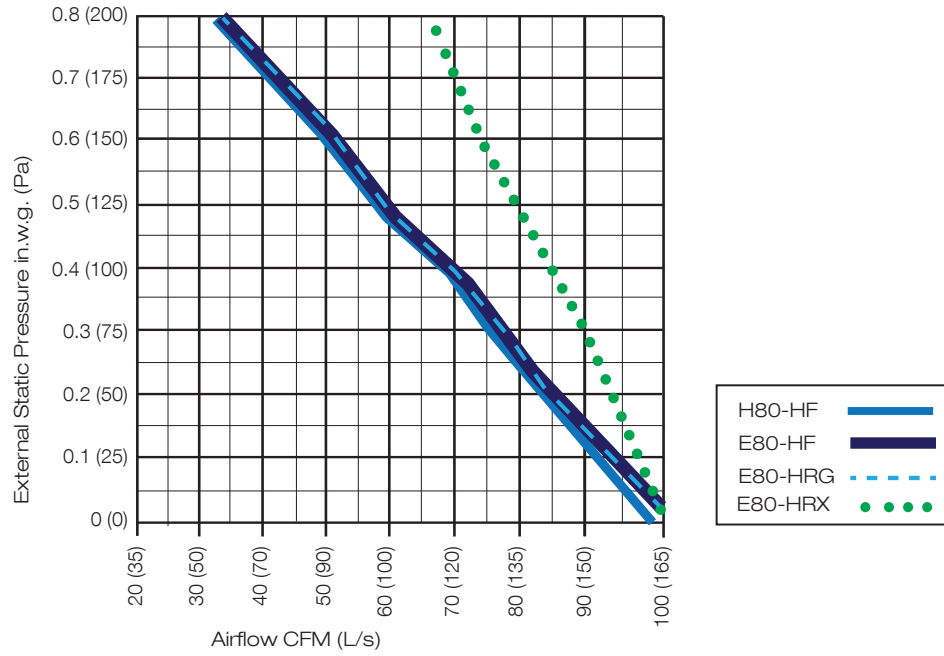

### RECOVERY PERFORMANCE: 80 MODELS

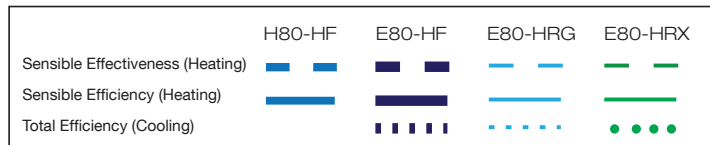
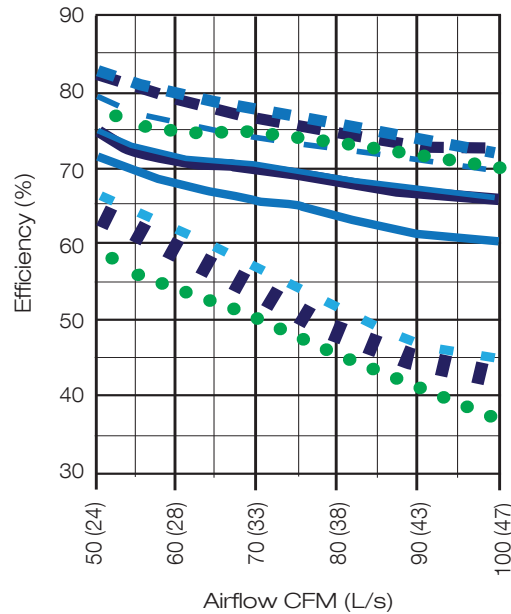

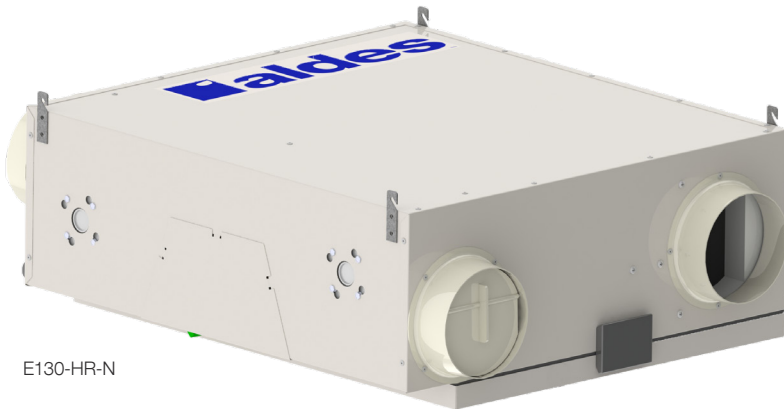

E130-HR-N

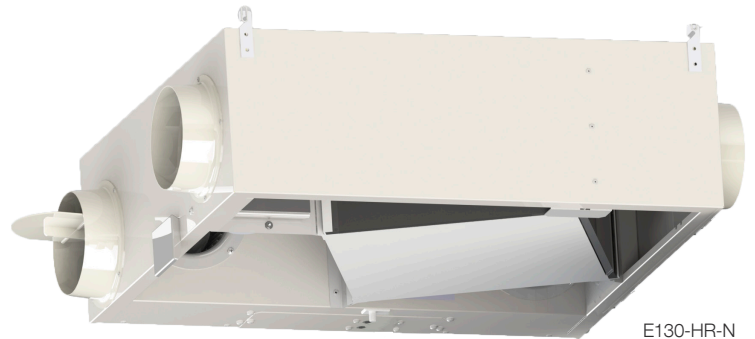

E130-HR-N

### PRODUCT DETAILS

- Rated for 90 CFM (E130-HF-N), 125 CFM (E130-HR-N), and 145 CFM (E130-HRX-N) at 0.4 in. w.g.
- High Latent Transfer (HLT) enthalpy core.
- 120 VAC electrical requirements.
- Backward-inclined impellers.
- Bottom-hinged access panel.
- Appliance-grade steel cabinet with baked-enamel finish.
- Lightweight construction – only 35 lb (16 kg).
- HVI Certified and ETL Safety Listed.

### KEY FEATURES

- Compact size (9-1/4" tall) permits installation in tight spaces.
- FLEXControl electronically balances airflow circuits for simple, accurate installation.
- Automatic, timed recirculation defrost for use in extremely cold climates.
- Exhaust defrost for E130-HF-N.
- No condensate drain required.
- Efficient EC motors (E130-HRX-N).
- Available with outdoor air ducts on either side to simplify duct layouts.



### DIMENSIONS

Side View (Left)

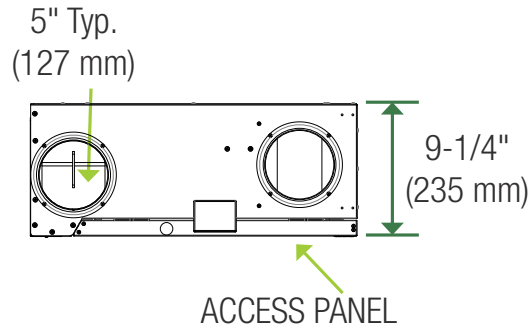

Bottom View

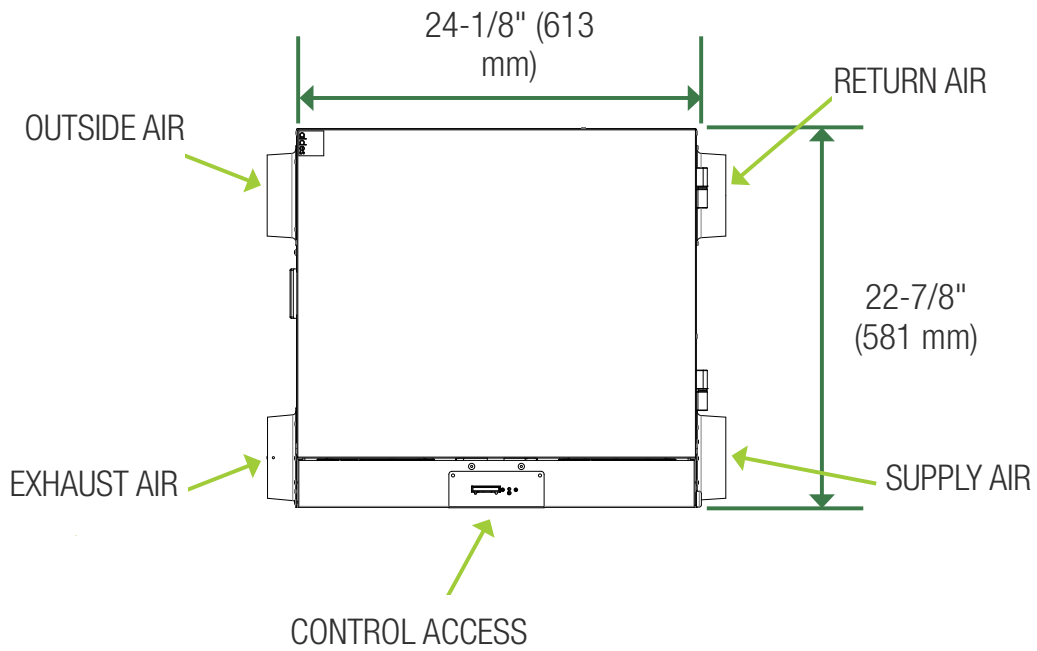

Side View (Right)

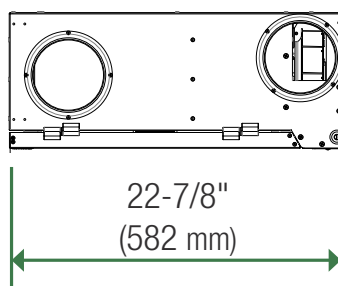



PERFORMANCE

**HVI CERTIFIED RECOVERY PERFORMANCE**

MODEL	E130-HR-N					E130-HRX-N				
	Heating			Cooling		Heating			Cooling	
	32°F (0°C)			-13°F (-25°C)	95°F (35°C)	32°F (0°C)			-13°F (-25°C)	95°F (35°C)
CFM (L/s)	50 (24)	72 (34)	100 (47)	50 (24)	51 (24)	50 (24)	66 (31)	102 (48)	64 (30)	49 (23)
Sensible Recovery Efficiency	70%	65%	61%	55%	--	67%	65%	61%	52%	--
Adjusted Sensible Recovery Efficiency	81%	76%	71%	73%	--	71%	69%	64%	55%	--
Latent Recovery/ Moisture Transfer	65%	59%	53%	57%	53%	36%	38%	48%	55%	49%
Total Recovery Efficiency	--	--	--	--	51%	--	--	--	--	53%

**VENTILATION PERFORMANCE: 130 MODELS**

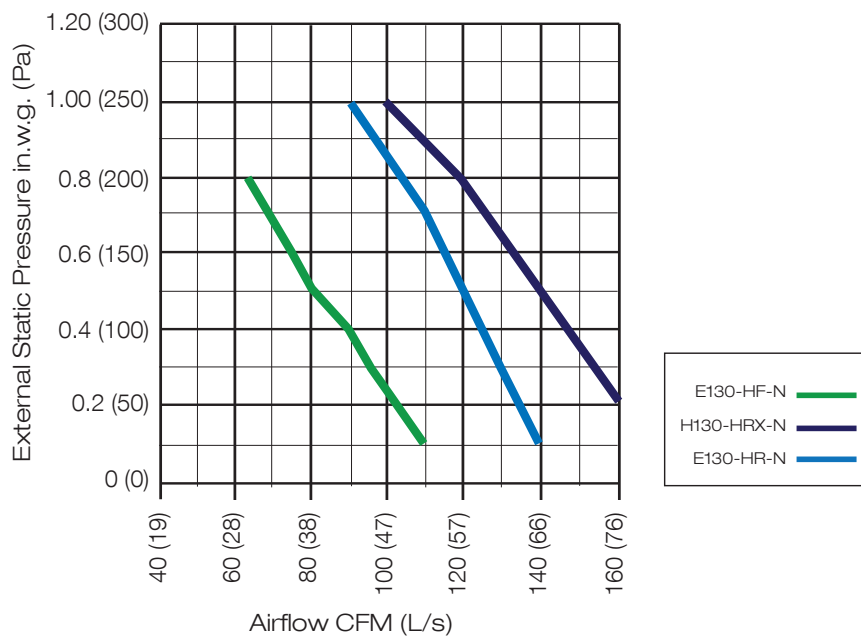

### RECOVERY PERFORMANCE: 130 MODELS

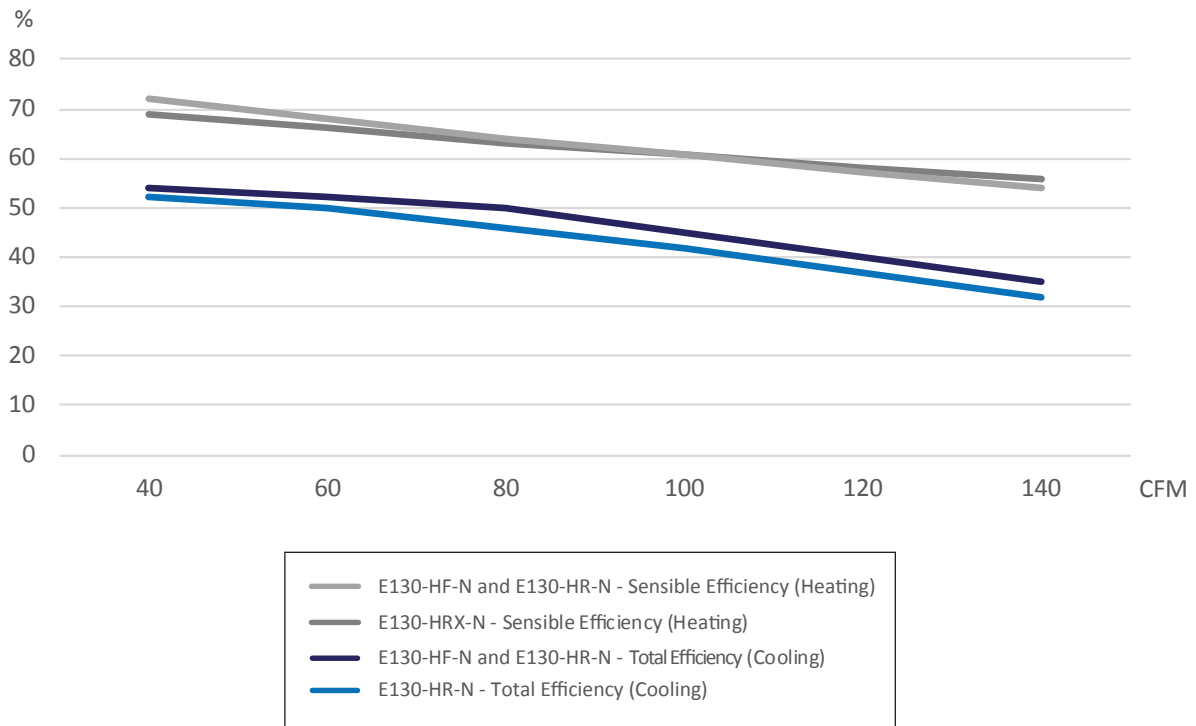

### INSTALLATION

InspirAIR® Compact units are slim in height, ideal for horizontal installations above ceilings and in narrow plenum spaces. Both, the 80 and 130 models are also narrow enough to easily fit between joists and other structural supports.

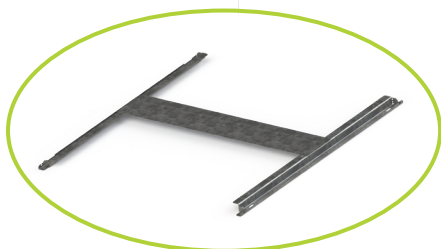
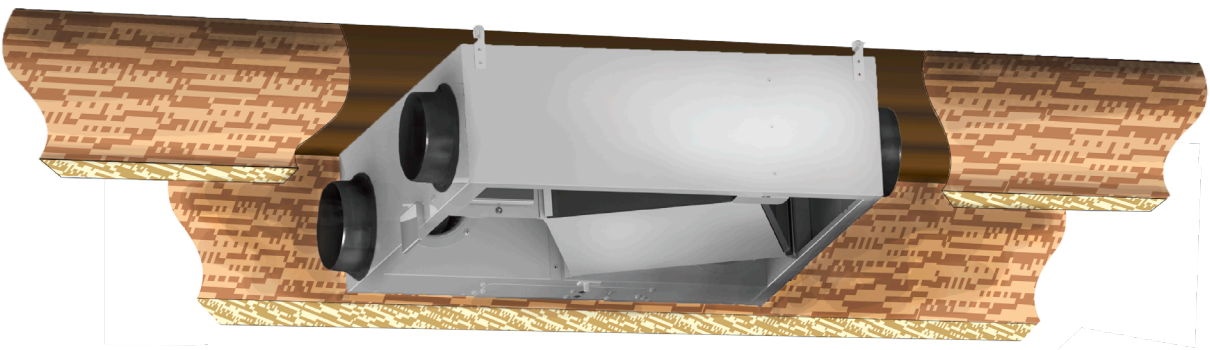

Mounting hardware is also available to ensure a secure vibration proof installation.

## APPLICATION

In the diagrams below, the InspirAIR® Compact HRV or ERV is mounted in the ceiling of the master bedroom closet.

The blue lines indicate the flow of fresh air for supply and the red lines indicate the flow of stale air for exhaust.

Each diagram depicts an acceptable duct configuration.

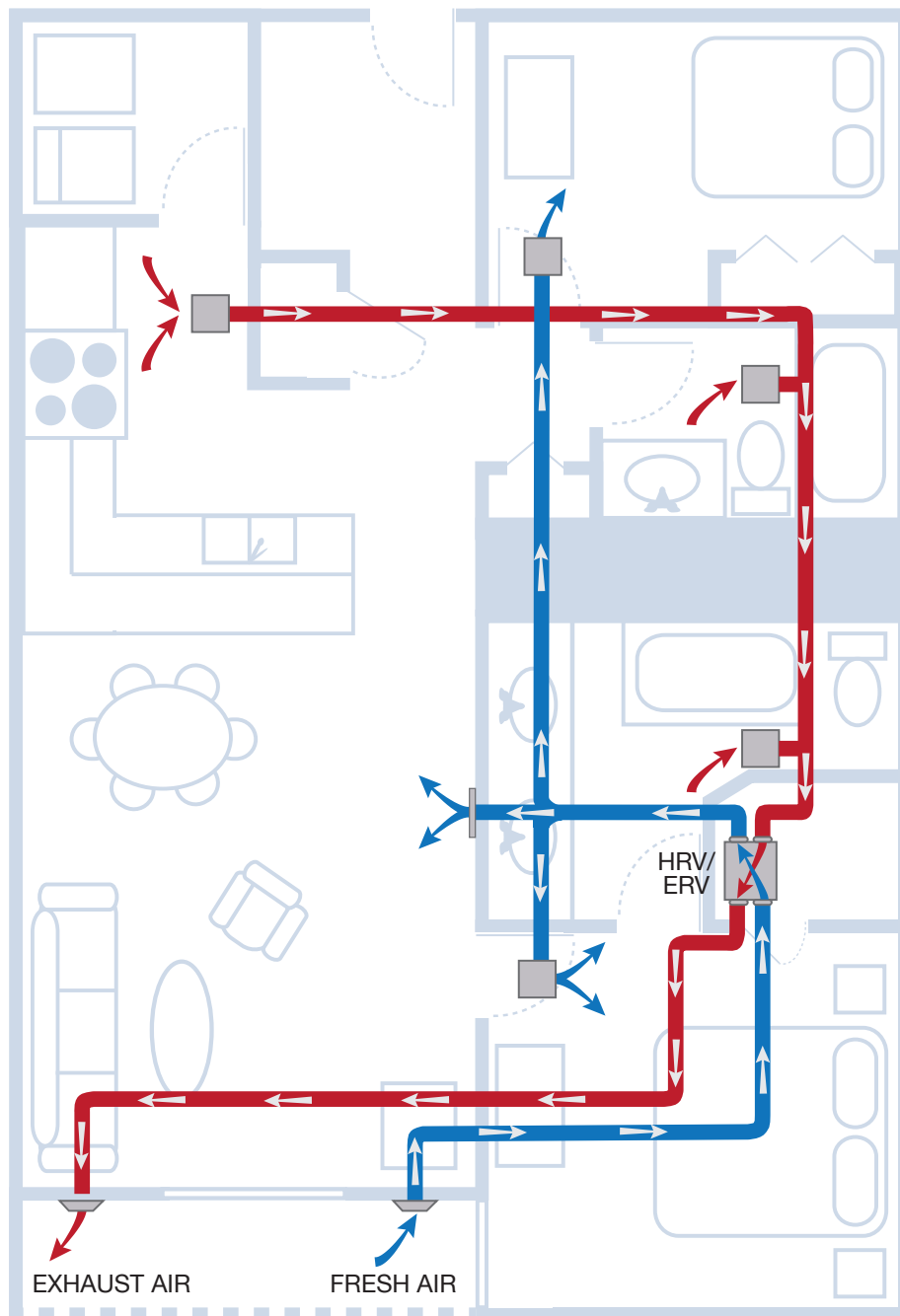

Fully ducted with exhaust air directly ducted to the outside and fresh air supplied by an inlet.

## APPLICATION

In the diagrams below, the InspirAIR® Compact HRV or ERV is mounted in the ceiling of the master bedroom closet.

The blue lines indicate the flow of fresh air for supply and the red lines indicate the flow of stale air for exhaust.

Each diagram depicts an acceptable duct configuration.

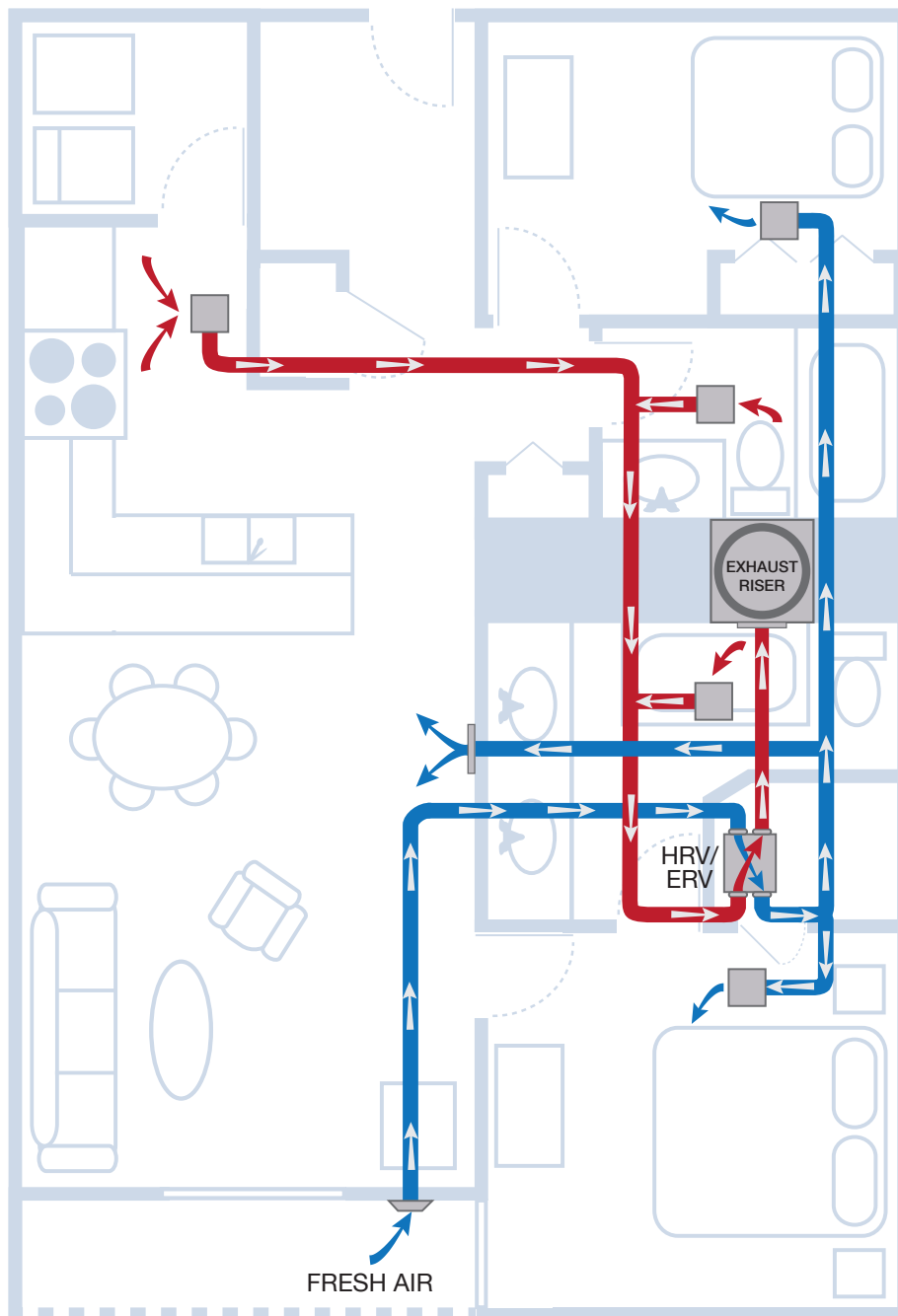

Fully ducted with exhaust air ducted to a central exhaust riser and fresh air supplied by an inlet.

---

**APPLICATION**

---

In the diagrams below, the InspirAIR® Compact HRV or ERV is mounted in the ceiling of the master bedroom closet.

The blue lines indicate the flow of fresh air for supply and the red lines indicate the flow of stale air for exhaust.

Each diagram depicts an acceptable duct configuration.

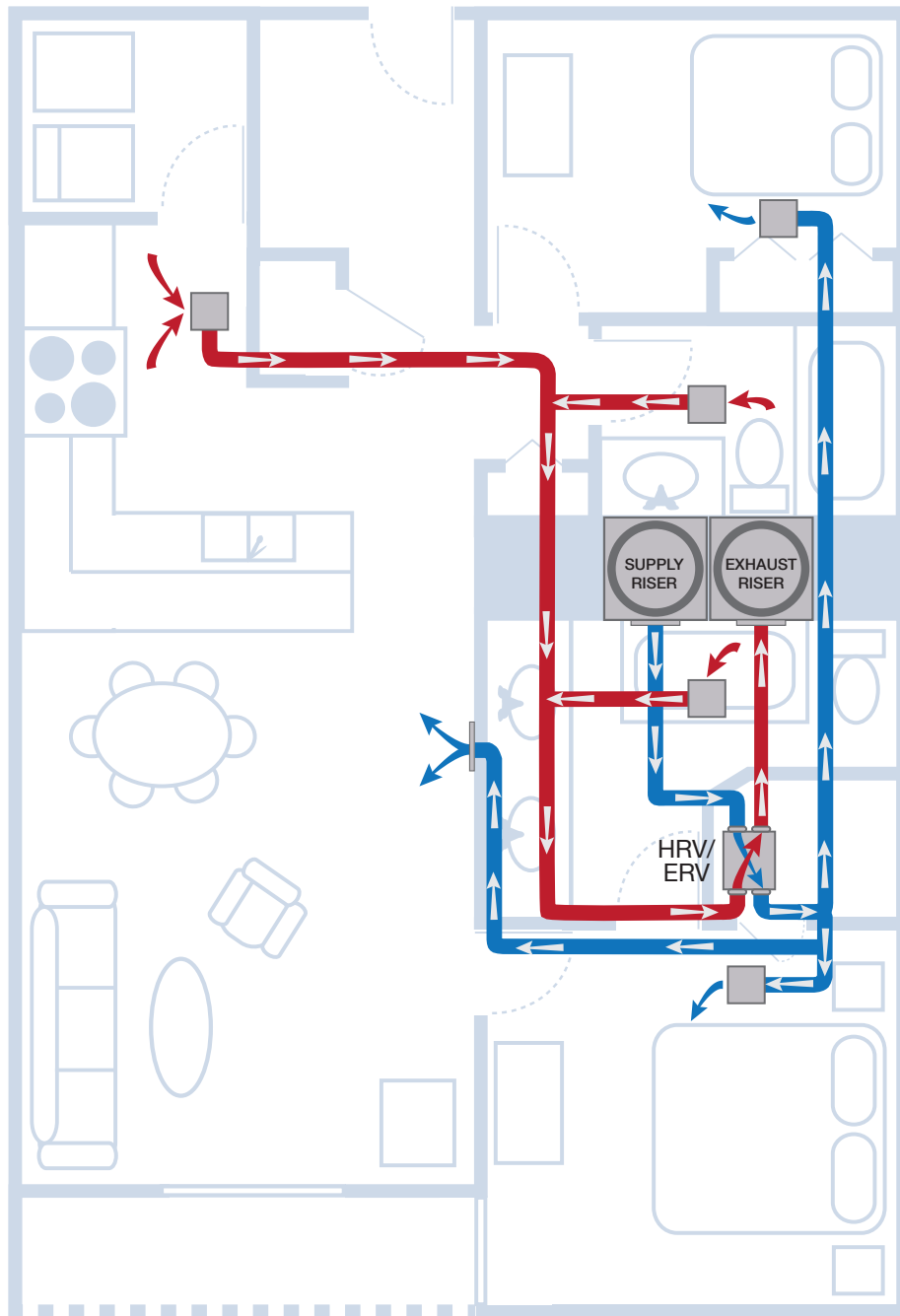

Fully ducted with exhaust air ducted to a central exhaust riser and fresh air supplied by a central riser.

## ACCESSORIES

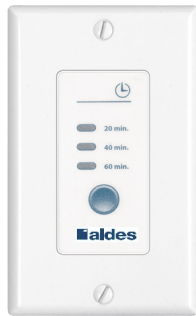
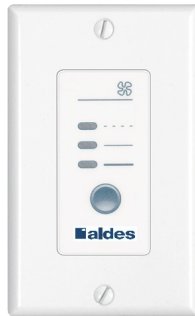
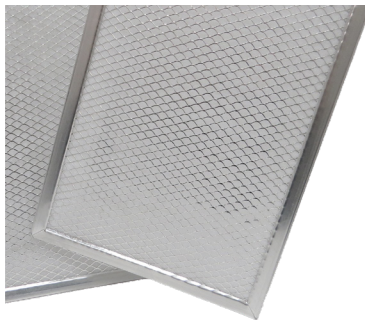
**1 - 20/40/60 Timer****2 - Speed Control****3 - Multifunction Control****4 - Washable Foam Filter****5 - MERV 6 / MERV 8 Filter****6 - High-Efficiency Filter****7 - Zone Register Terminal  
(ZRT®)**

## ACCESSORIES

### DESCRIPTION

- 1 20/40/60 Timer (P/N 611228)
  - Activates the HRV/ERV to operate on high-speed mode for 20, 40, or 60 minutes.
- 2 Speed Control (P/N 611229)
  - Four HRV/ERV speeds: intermittent mode, low and high-speed exterior exchange mode, and unit stop mode.
- 3 Multifunction Control (P/N 611242-FC)
  - Gives complete control over the HRV/ERV and supports the free cooling economizer mode (on E80-HRG and E80-HRX).
- 4 Washable Foam Filter (P/N 612405)
  - Traps impurities.
- 5 MERV 6 Filter (P/N 612415) & MERV 8 Filter (P/N 683961)
  - Traps impurities.
- 6 High-Efficiency Filter (P/N 612407)
  - Traps impurities and pollen; use on the supply side only.
- 7 Zone Register Terminal (ZRT®)
  - Increase system efficiency and eliminate noisy bathroom fans.

Range			
Accessory	Part Number	H130-HRG-N, E130-HF-N,E130-HR-N, E130-HRX-N	H80-HF-N, E80-HF-N, E80-HRG-N, E80-HRX-N
1 - 20/40/60 Timer	611228	√	√
2 - Speed Control	611229	√	√
3 - Multifunction Control	611242-FC	√	√
4 - Washable Foam Filter	612405	√	
5 - MERV 6 Filter	612415		√
5 - MERV 8 Filter	683961	√	
6 - High-Efficiency Filter	612407	√	
7 - Zone Register Terminal (ZRT®)	ZRT®	√	



For more information, contact your  
ALDES sales advisor, visit [ALDES-na.com](http://ALDES-na.com),  
or find us on



ALDES North America  
USA 800.255.7749 CAN 800.262.0916

040624- Commercial HRV&ERV Brochure  
©2024, American ALDES Ventilation Corporation and ALDES Canada. All Rights Reserved.  
Reproduction or distribution, in whole or in part, of this document, in any form or by any means, without the express written consent of American ALDES Ventilation Corporation and/or ALDES Canada, is strictly prohibited.  
The information contained within this document is subject to change without prior written notice.

