

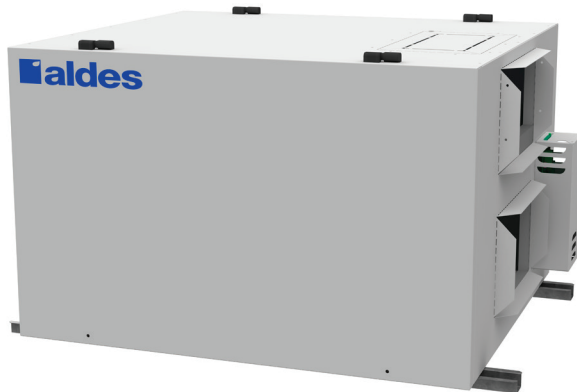

INSTALLATION AND OPERATING GUIDE



Air exchanger with heat or energy recovery-core

H650	H650A	E650	E650L
H1100	H1100A	E1100	E1100L
H1800	H1800A	E1800	E1800L

Read carefully and conserve for future reference

Table of contents

1	Welcome	
	Table of contents	2
	Introduction	3
	Air exchanger with heat recovery	3
2	Installation preliminaries	
	Box contents	4
	Wall controls	4
3	Location	
	Of the unit	5
	Of inlet grilles	5
	Of diffusers	5
	Of the humidity control	5
4	Installation	
	Cabinet	6
	Exhaust louver	6
	Inlet louver	6
	Wall controls	6
	Humidity Control	6
	Ducts	7
	Electrical connection	7
	Air balancing	9
	Unit connection	9
	Unit configuration	12
5	Operation	
	Unit	13
	Dehumidistat	14
	Humidistat	15
	Timer	18
	Wall controls	18
6	Maintenance	19
7	General information	
	Warranty	21
	Contact information	22
	Product information	22
	Product information	23

Introduction

Thank you for purchasing a new Aldes ventilation system. The information in this guide will allow you to install and maintain the system so that it delivers fresh, healthy air to the building occupants for many years to come.

Before you begin, please take a moment to fill out the product information section at the end of this guide. This information is required for any future warranty claims.

Air exchanger with heat recovery

This unit is specially designed to change the air in your office or small business. This air exchanger will ensure continuous ventilation on request. In winter, it will dehumidify the ambient air to the level set on the control. Bad odors will also be exhausted with the proper wall-mounted accessory and the life span of your building will be extended.

Box contents

Check if all the parts are included in the package.

- Air exchanger
- Parts included
 - 2x 3/8 & 1/2 universal drain
 - 2x Seal grommets
 - 2x Nuts
 - 1x Drain hose "T" connector
 - 11' drain hose

Wall controls

Additional parts can be bought to complete the installation. The following parts are recommended for a standard installation.

- Digital Multifunction Wall Control (611242-FC)
- Electronic dehumidistat (611227)
- Manual dehumidistat (611224)
- Speed Control (611229)
- 20/40/60 Minute Timer (611228)

Of the unit

The ALDES unit should be installed in an area where the temperature is always above the freezing point.

The best location for the unit would minimize the total duct length and the number of elbows. The shorter the ducts and the fewer elbows there are, the higher the airflow will be.

Of inlet grilles

The ambient air inlet grilles should be mounted close to areas with higher humidity levels. Most of the time, they are located, on the main floor, in the corridor between the kitchen and the washroom and, in the basement, close to the washroom. It should not be located in a room containing a combustion appliance like a furnace or a fireplace. The grilles can be installed on the ceiling or a wall. Place the grille within 12" (30 cm) of the ceiling.

Of diffusers

The diffusers are normally installed in corridors as far from the ambient air intake as possible. This forces the air to circulate through most of the building.

The diffuser can be installed on a wall or the ceiling. If it is located in an occupied area, we recommend mounting the diffuser on the ceiling. This allows the fresh air to be mixed with the ambient air before reaching the occupants, thus improving the comfort level during a cold winter day. A wall-mounted diffuser should be located within 12" (30 cm) of the ceiling.

Of the humidity control

The control has to be installed where excess humidity is more likely to be detected. On the main floor, it is generally located between the kitchen and the bathroom.

If you wish to control the humidity level mainly in the basement you should install the control in this area. Avoid placing the control in an area with stagnant air, for example behind a door.

The installation of the air exchanger must be in accordance with the applicable codes in your area.

Cabinet

The unit is designed to be installed on a shelf or suspended to the structure. When the unit is on a shelf, it is necessary to have some vibration insulators under its casing to prevent noise propagation.

The air exchanger must be leveled horizontally. This is necessary to drain the condensation out of the unit. Connect 2 hoses to the bottom of the casing (see drawing), the main drain should be connected to the building drainage system.



Exhaust louver

The exhaust louver is installed through an exterior wall at a minimum of 18" (46 cm) above ground. Attach the intermediary sleeve to the plastic louver collar with a crew. Seal the gap between the sleeve and the wall.

Inlet louver

The inlet louver is installed through an exterior wall, at more than 6' (185 cm) from the exhaust louver and more than 18" (46 cm) above ground. Make sure the inlet louver is installed so the insulated vent duct, joining it to the cabinet, is as straight as possible.

Wall controls

Wall controls should be mounted, 5' (150 cm) above the floor.

Drill a hole through the wall so you can pass a wire from the control to the unit. This wire contains 4 wires of different colors. Connect them to the terminal block of the air exchanger, following the color code.

Attach the backplate of the control to the wall, over the wire. Connect the wires to the back of the control, following the color code. Adjust the dip switches at the back of the control according to the functionality required (please refer to the installation guide for the control). Install the plastic cover with the help of the fixing screw and the control button, if needed.

Ducts

To maximize the air exchanger airflow, install the ducts as straight as possible. We recommend galvanized steel ducts for long ductwork because of their ease of cleaning and low flow resistance.

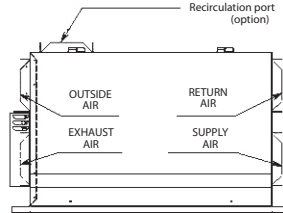

You can run ducts through floors, ceilings, walls or closets and cover them thereafter with drywall. Ducts in unheated areas must be insulated. The last 3' (1 m) of the exhaust duct adjacent to the exhaust louver should be insulated and covered with a vapor barrier. Slide end of flexible duct over unit port. Use 2" duct tape to wrap the flexible duct to the unit port. If necessary, the gaps between ducts and walls or ceilings can be hidden with the rubber strips.

Electrical connection

Once all the ducts are installed and the wires for the controllers are connected, connect the HRV/ERV to a power source according to the model type.

HRV/ERV with Electronically Commutated (EC) Motors:

If the supply voltage is 230V then continue to wiring instructions. If the supply voltage is 208V then make the following modification:

1. Remove the cover of the ventilator's electrical panel using a screwdriver.
2. Locate the transformer, as illustrated in Figure 1.
3. Remove the wire connector from the pin on the right (labelled 230V) and connect it to the centre pin (labelled 208V), as shown in Figure 2.
4. Replace the control panel cover and screws.

All HRV/ERV models:

If the HRV/ERV has a power cord, then plug the unit into a standard 120V NEMA 5-20 receptacle with ground (AC motors) or a 230V NEMA 6-15 receptacle with ground (EC motors). **DO NOT USE AN EXTENSION CORD.**

If the HRV/ERV does not have a power cord (model numbers ending in -N), it must be wired to the building mains by a licensed electrician according to applicable electrical and building codes.

Electrical connection (continued)

To wire the HRV/ERV:

1. Ensure that the circuit breaker is turned off during installation.
2. Locate the junction box on the HRV/ERV.
3. Remove the junction box cover with a Phillips-head screwdriver. Retain the screws for later when replacing and securing the junction box cover (Step 7).
4. Insert the electrical conduit into the 7/8" (22.3 mm) hole in the junction box cover and secure it with a clamp or washer and screw.
5. Pass the wire through the conduit.
6. Strip insulation 1/4" (6.4 mm) from the ends of the wires.
7. Connect the wires to the HRV/ERV terminal block
8. Replace the junction box cover over the box and secure it using the screws from Step 2.
9. Turn on the circuit breaker and confirm that the HRV/ERV powers up.

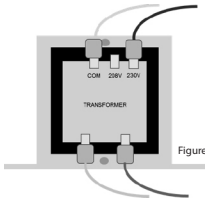

Figure 1: Transformer Wiring for 230V

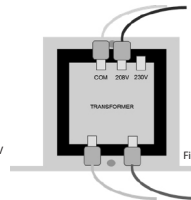

Figure 2: Transformer wiring for 208V

4 INSTALLATION

Air balancing

The difference between the exhaust and supply airflow rates should be under 10%. Airflow balancing is especially important in houses with combustion appliances or in areas where radon gas may be a problem. Use airflow measuring stations and a magnehelic gauge to measure the airflow rates.

The speed of each blower can be adjusted independently by turning the adjustment knob located on the top of the electrical box.

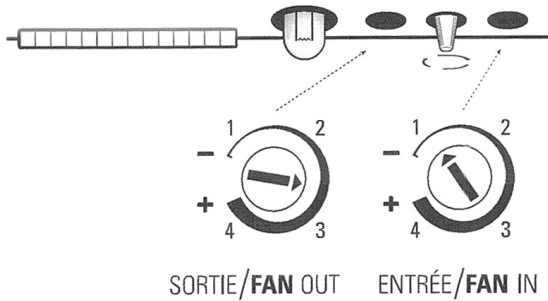

Unit connection

It is recommended to use 22 gauge wire. Always have a jumper between 9 & 10.

- Wall-mounted accessories
Wall-mounted accessories must be installed at approximately 5' (150 cm) from the floor and connected to the device according to the following illustration.

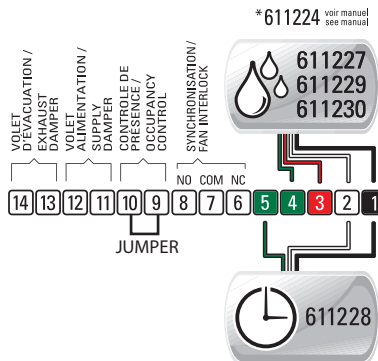

14	BLANC WHITE
13	BLANC WHITE
12	BLANC WHITE
11	BLANC WHITE
10	BLANC WHITE
9	BLANC WHITE
8	BLANC WHITE
7	BLANC WHITE
6	BLANC WHITE
5	VERT GREEN
4	VERT GREEN
3	ROUGE RED
2	BLANC WHITE
1	NOIR BLACK

4

INSTALLATION

For the connection of the humidistat 611224 or DRY CONTACT, see the following illustrations according to the installation needs.

WITHOUT recirculation option

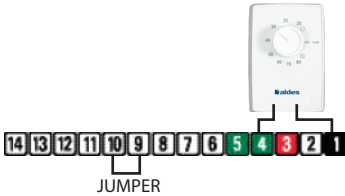

WITH recirculation option

Option 1: the unit is in EXCHANGE mode at DEFAULT SPEED

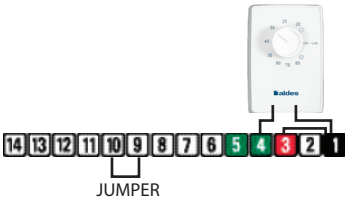

Option 2: the unit is in RECIRCULATION mode at DEFAULT SPEED

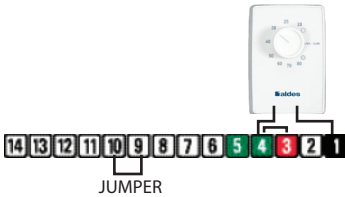

- Synchronization contact

The unit has a dry contact either NO or NC for fan interlock with a heating or cooling system.

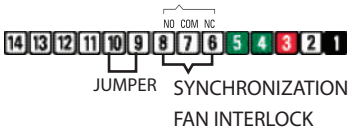

4 INSTALLATION

- Occupancy Control

This dry contact offers priority control operation; it can be used to connect a programmable timer or a motion detector to limit the unit's operation periods. When this contact is activated, the unit functions normally according to the wall-mounted accessory. A jumper should be between 9 & 10.



- Supply and exhaust damper

These contacts make it possible to feed two damper actuator; one for the supply airstreams and one for the exhaust airstreams (24 Volt AC, 10 VA max each).

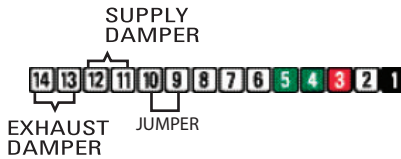

Or if you want the unit in exchange mode at the lowest speed put a jumper from 1 to 3.

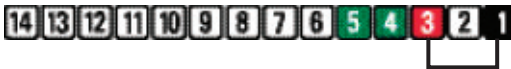

If you use the unit without a control, depending of the use of the unit, you have to put a jumper from 1 to 5 if you want to be in exchange mode at HIGH speed.

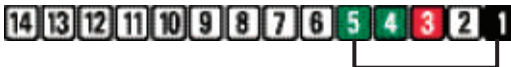

4 INSTALLATION

Unit configuration

It is possible to change the defrost parameters and speed range using the jumper on the configuration port. The configuration port is located on the control board as indicated on the figure below.

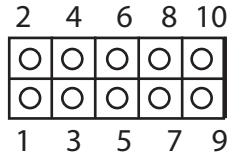
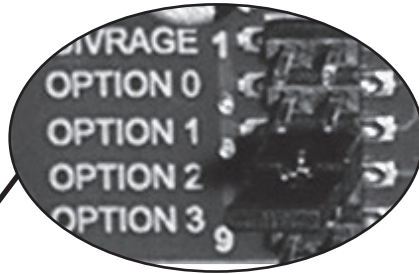
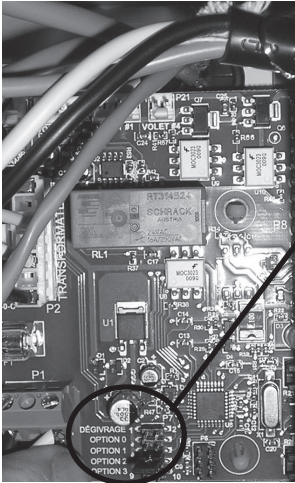

Configuration port

- **EXTENDED DEFROST Option**

For severe applications, in colder area, it is possible to extend defrost period in order to prevent ice build-up in the unit. To activate the extended defrost option, add a jumper on the configuration port between terminals 1 and 2 (DEGIVRAGE position).

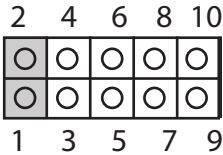

- **REDUCED SPEED Option**

To operate the unit according to the REDUCED speed range (see data sheet for performance), add a jumper on the configuration port between terminals 3 and 4 (OPTION 0 position).

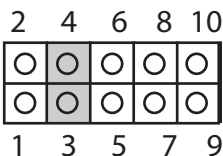

5 OPERATION

Unit

The unit will function according to the speed selected using the button located on the side of the device (see figure below). A pilot light indicates selected speed. This speed is called **DEFAULT SPEED** or speed ❶ it is the speed to which the unit operates when no signal is emitted by the wall-mounted accessories (humidistat, timer, etc) connected on terminals 1 to 5. When a signal is emitted by one of the wall-mounted accessories, the unit is activated at **HIGH SPEED** or speed ❷

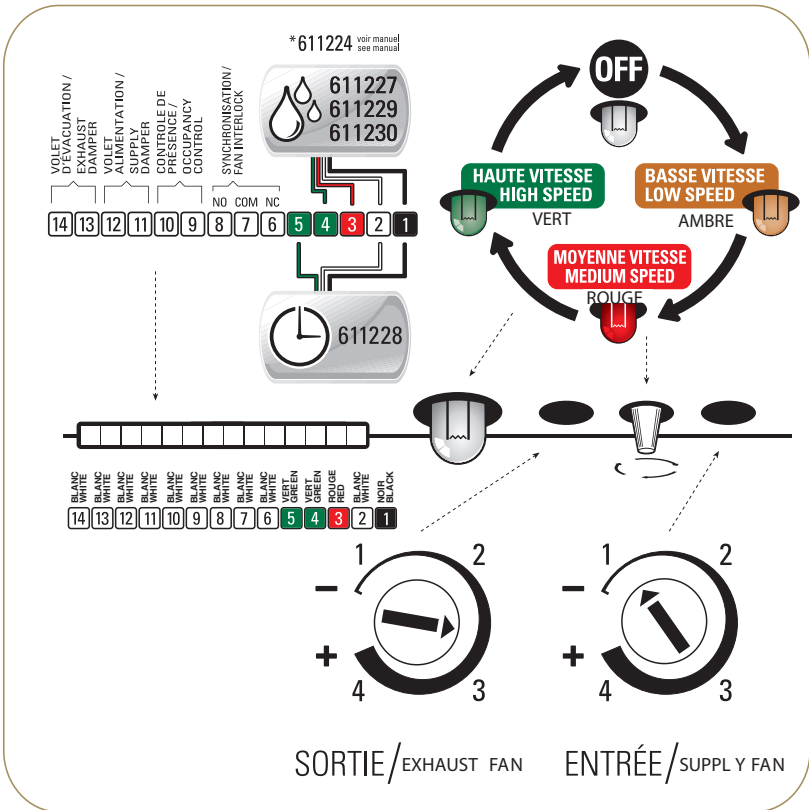

Dehumidistat

The dehumidistat controls the relative humidity rate. Equipped with a humidity sensor and a electronic system, it efficiently controls your air ex-changer to remove excess humidity from the building.

The dehumidistat is designed to quickly evacuate all excess humidity. When the indoor relative humidity exceeds the desired setting, this features causes air to be exchanged with the outside at a high speed until the indoor relative humidity drops below the set point. Afterwards, it will automatically come back to the chosen operating mode.

Note that the dehumidistat is intended to be used when the outdoor air has less moisture content than the indoor air. Turn off the dehumidistat when outdoor air is hot and humid.

ASHRAE standards recommend maintaining a relative humidity between 30% and 60%.

RECOMMENDED RELATIVE HUMIDITY TO PREVENT INDOOR CONDENSATION	
Outside air temperature	Relative humidity
10°C / 50°F	Between 55 % and 60 %
0°C / 32°F	Between 50 % and 55 %
-10°C / 14°F	Between 45 % and 50 %
-20°C / -4°F	Between 40 % and 45 %
-30°C / -22°F	Between 30 % and 40 %

*Values may vary according to the type of construction and fenestration of your house.

Humidistat model 611224

The mechanical humidistat controls excess humidity. When the rate of humidity is greater than the value indicated on the adjustment knob, activate the high speed switch and if needed, the interior-exterior exchange switch. When the appropriate humidity rate is reached, the humidistat returns to its pre-selected ventilation mode.

Turn the adjustment knob from the humidity's higher value toward its lower value and, when you hear a click, look at the value indicated. This value represents the rate of ambient moisture in the air.

You may also wish to operate the appliance at high speed. To do so, adjust the knob to its lowest rate of humidity (20%). This setting is recommended for a room full of guests or an extended period of cooking.



Humidistat Model 611227

Electronic humidistat with liquid crystal display

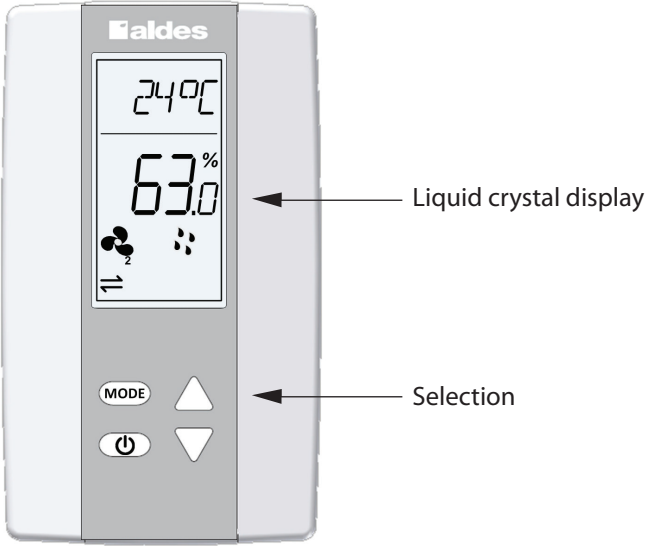

Presentation of the display window

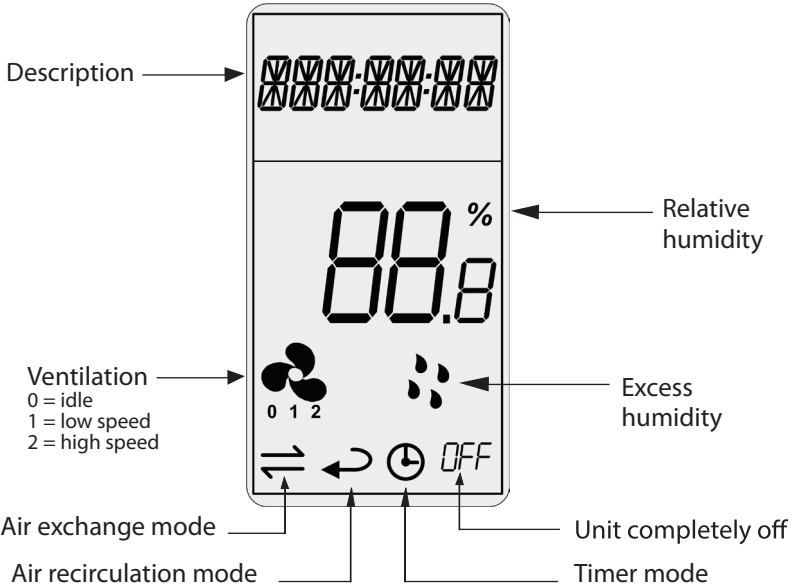

5 OPERATION

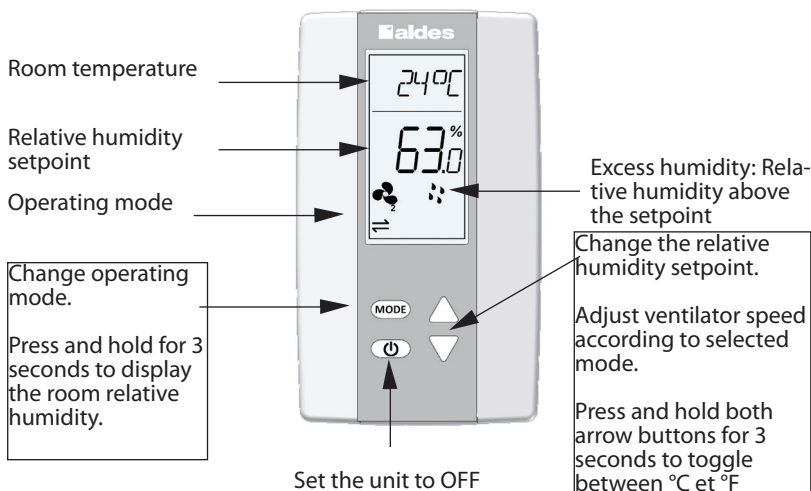

Operating mode

Mode	Speed	Description
OFF	-	Unit stops completely. Remains idle regardless of the humidity level.
⇕	0	Remains idle until the humidity goes above the setpoint.
	1	Continuously exchanges air with the outside at low speed.
	2	Continuously exchanges air with the outside at high speed.
↻	1	Recirculates interior air at low speed.
	2	Recirculates interior air at high speed.
⌚	1	Exchanges air with the outside at low speed for 20 minutes. Then remains idle for 40 minutes.
↻⌚	1	Continuously exchanges air with the outside at low speed for 20 minutes. Then recirculates interior air at low speed for 40 minutes.

5 OPERATION

Timer Model 611228

When you push the button the unit will continuously exchange air at high-speed for a period of:

- 20 minutes
- 40 minutes
- 60 minutes

This control overrides the mode of operation selected on the humidistat.

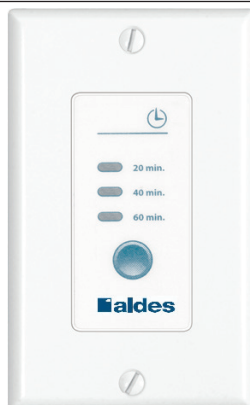

Speed Control Model 611229

Function : Provides the ventilation unit with 4 modes of operation:

- Intermittent mode; successive cycles, low-speed 20-min exchange, 40-min stop mode
- Low-speed exterior exchange mode
- High-speed exterior exchange mode
- Stop mode (when the lights are off)

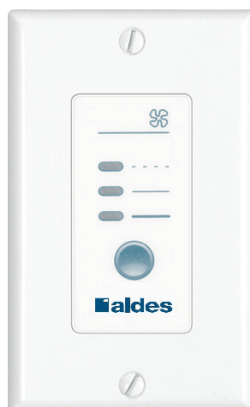

General Maintenance

WARNING: ALWAYS UNPLUG THE DEVICE BEFORE PERFORMING MAINTENANCE

To access internal components: Remove or lift up the unit door. Remove the unit door by

opening the latch and lifting the door off the hinges.

1. Exterior Wall Hoods (inspect at least once a month)
 - a. Make sure they are not blocked or obstructed.
 - b. In winter, it is especially important to make sure snow is not blocking the hoods or that ice has not built up on the screen.
 - c. Blocked hoods can cause an imbalance.
2. Air Filters
 - a. With door removed or lifted up, remove the filters.
 - b. Follow the cleaning schedule and procedure for your unit's filter type.

3. Recovery Core

- a. With door removed or lifted up, remove the filters. Next remove the recovery core by gently pulling it from the device. Wear gloves to protect your hands from the core's sharp edges.
- b. Follow the cleaning procedure for your unit's core type:
 - Polypropylene, Gently vacuum the surface of the core, soak in warm soapy water, then rinse thoroughly and leave to dry.
 - High-La tent-Transfer: Gently vacuum the surface of the core
- c. To properly install the clean core:
 1. Mount the bottom flange of the core guide into the bottom H channel approximately 1/4" (6mm).
 2. Mount the left or right side flange of the core guide approximately 1/4" (6mm) followed by the other side.
 3. Mount the top flange of the core guide into the top H channel approximately 1/4" (6mm).
 4. When all four corners are in place and the core is straight and even, push hard in the center of the core until the core stops on the back of the cabinet.

4. Motors (No maintenance needed)

5. Condensate Drain - Clean once a year

- a. Inspect drain line, drain spout, and "P-Trap" for blockages, mold or kinks.
- b. Flush with warm, soapy water.

6 MAINTENANCE

c. Replace if worn, bent, or cannot be cleaned. See page 18 Section “Drain

Connections (HRV Models)” for installing condensate drains.

6. Duct Work (as needed)

a. The ductwork running to and from the HRV/ERV may accumulate dirt.

b. Wipe and vacuum the ductwork once every year.

c. It may be preferable to contact a company that specializes in duct cleaning.

7. Cabinet (twice a year)

a. With the door removed, wipe down the inside of the cabinet with a damp

cloth to remove any dust or debris.

b. ONLY USE WATER. DO NOT USE PRODUCTS CONTAINING SOLVENTS. DO NOT

USE HOUSEHOLD CLEANING PRODUCTS.

c. Wipe the interior with a dry cloth.

8. Fans (No maintenance needed)

After Performing Maintenance: Slide the core and filters back into the unit. Re-attach the

door to its hinges and latch the handle. Plug the unit into its power source.

Replacement Filters

Part Number	Filter Type	Applicable Models	Quantity
683901*	Aluminum	H/E650	4
683902	MERV 8	H/E650	4
683903	Carbon	H/E650	4
683904	High Efficiency	H/E650	4
683906	MERV 8	H/E1800	6
683907*	Aluminum	H/E1800	6
683908	Carbon	H/E1800	6
683909	High Efficiency	H/E1800	6
683951*	Aluminum	H/E1100	6
683952	MERV 8	H/E1100	6
683953	Carbon	H/E1100	6
683954	High Efficiency	H/E1100	6

* Filters that originally shipped with the unit

Warranty

The warranty period for light commercial ventilation units begins on the date of manufacture indicated on the serial number (modelYYMMXXX where YY is the year and MM the month).

All models are covered by a 2-year limited warranty with the following exceptions: HRV heat recovery cores are covered by a 15-year limited warranty. The ERV High Latent Transfer core is covered by a 5-year limited warranty.

The Seller warrants to the Purchaser that any equipment manufactured by it and bearing its name plate, to be free from defects in material and workmanship, under proper and normal use and service as follows: If, at any time within the warranty of the product (see individual specifications), the Purchaser notifies the Seller that, in his opinion, the equipment is defective, and returns the equipment to the Seller's originating factory prepaid, and the Seller's inspection finds the equipment to be defective in material or workmanship, the Seller will promptly correct it by either, at their option, repairing any defective part or material or replacing it free of charge and return shipped lowest cost transportation prepaid (if Purchaser requests premium transportation, Purchaser will be billed for difference in transportation costs). If inspection by the Seller does not disclose any defect in material or workmanship, the Seller's regular charges will apply. This warranty shall be effective only if use and maintenance is in accordance with our instructions and written notice of a defect is given to the Seller within such period. This warranty is exclusive and is in lieu of any other warranties, oral or implied, specifically, without limitation, there is no warranty of merchantability or fitness for any purpose. The liability of the Seller is limited to the repair or replacement of materials or parts as set forth.

Limitation of Liability: The Seller shall not be liable for any claim or consequential or special loss or damage arising or alleged to have arisen from any delay in delivery or malfunction or failure of the equipment. The Seller's liability for any other loss or damage arising out of or connected with the manufacture or use of the equipment sold, including damage due to negligence, shall not in any event exceed the price of the equipment supplied by Seller.

How to File a Warranty Claim Before removing a defective product, contact Aldes for technical assistance. If a part is proved defective, it will be replaced with another part or repaired according to the company's assessment. Before returning a defective product for repair, contact Aldes customer service to obtain a Return Materials Authorization (RMA). Send the defective part postage paid to the address below based on your residence. It will be returned to you postage paid.

Contact information

For more details on the installation or the operation of your unit contact your dealer or the staff of our division. We will be glad to help you.

American ALDES Ventilation Corporation
4521 19th St. Ct. E.
Suite 104
Bradenton, FL 34203
1-800-255-7749
www.aldes.us

Aldes Canada
100 Rue Carter
Saint-Leonard d'Aston,
QC J0C 1M0
1-800-262-0916
www.aldes.ca

Product information

Date of purchase* _____

Serial number _____

Store (dealer) _____

*Keep your invoice as proof of purchase.

Maintenance sheet	Date



ADDENDUM, replaces page 12 in Installation,
Operations and Maintenance Guide 609242

LIGHT COMMERCIAL HEAT & ENERGY RECOVERY VENTILATORS

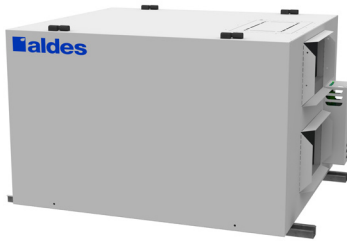

FOR MODELS:
H/E650 • H/E1100 • H/E1800

TO BE COMPLETED BY CONTRACTOR AFTER INSTALLATION

Installer: Leave this manual for the building owner

Model

Installing Contractor

Telephone / Contact

Serial Number

Installation Date

Electrical diagram

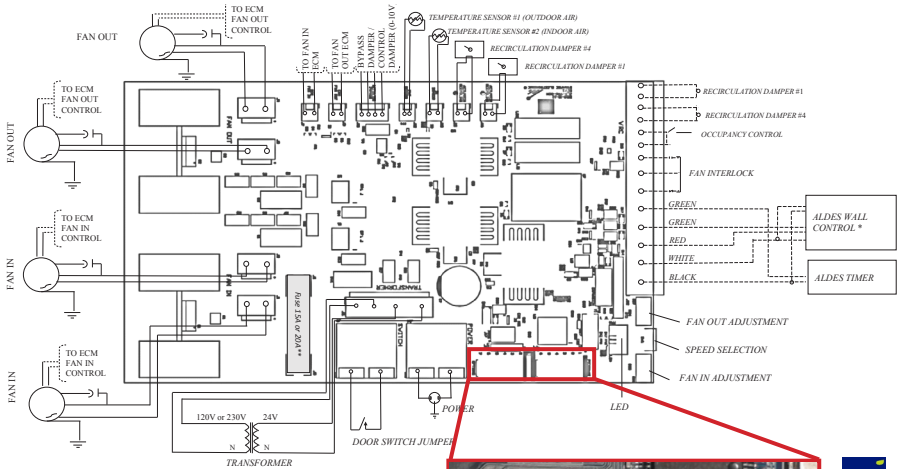

* Refer to the user guide for Aldes wall control installations

** fuses 15A or 20A are replaceable

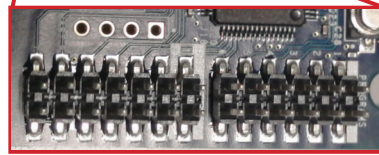

Options jumper block Programs jumper block

Configuration Options

In order to configure the different modes on your unit, you may need to move jumpers on the unit's printed circuit board. This can be done without any special tools following the directions below. It is recommended to do this first before any other installation steps.

1. Disconnect the unit power cable to avoid electric shock or damaging the PCB.
2. Remove the unit's terminal block by firmly pulling it straight out.

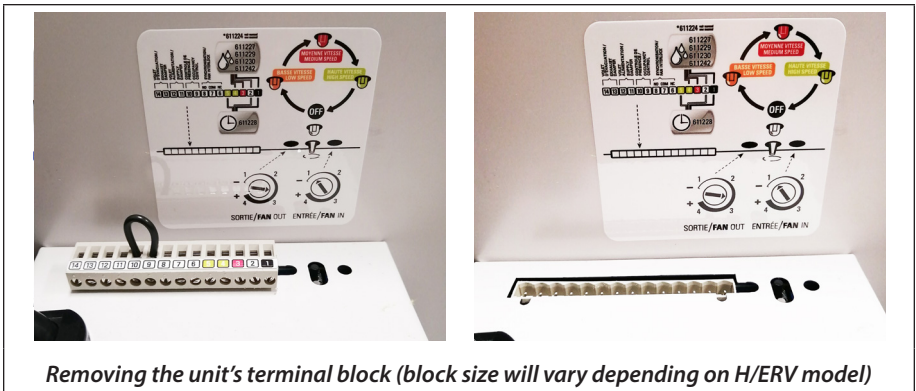

Removing the unit's terminal block (block size will vary depending on H/ERV model)

- Using a Phillips head screwdriver, remove the two screws that secure the metal control board cover.

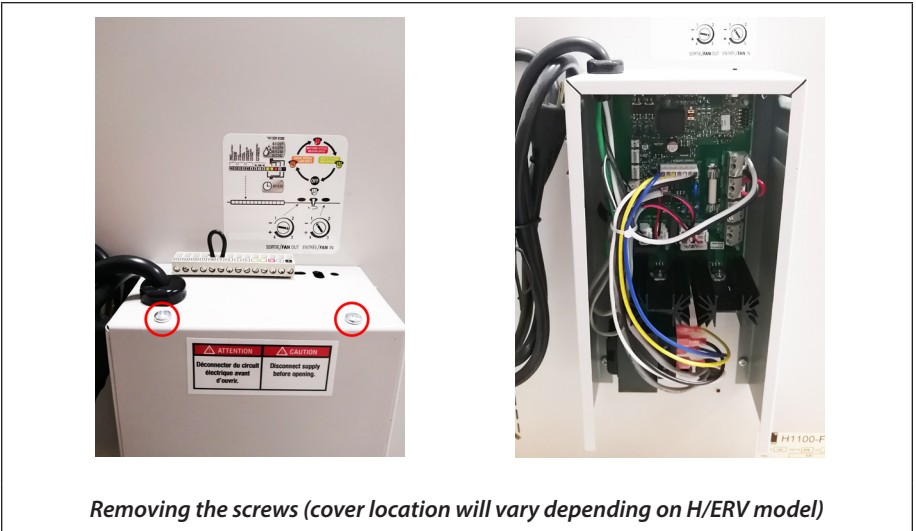

- With the cover removed, locate the jumper pins on the control board. These are positioned just behind the motor speed dials on the front of the unit. In the next few pages, you will find how to set the jumpers to enable or disable your options.
- In order to configure the different modes available for the unit, you will need to move different jumpers in the Options jumper block. It is the block with jumper pins ranging from 1 through 7. Below are the configurations for the different options available.

5a) Defrost modes

- » By default, the HRV/ERV is configured for **Normal Defrost**, with no jumpers on rows 5 and 6. Normal Defrost is optimized for most climate zones. The unit will automatically protect the core from frost build up by periodically switching to high speed recirculation or exhaust.
- » For extremely cold climates, you can choose the **Extended Defrost** option which increases the time in which the unit stays in the defrost cycle. To activate the Extended Defrost option, position a jumper on row 6 and make sure it connects both pins in the row.

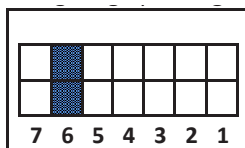

- » The **Comfort Defrost** option prevents the HRV/ERV from switching from low to high speed and back during defrost cycles, so there will be no audible difference between exchange and defrost. To activate Comfort Defrost, position a jumper on row 5 and make sure it connects both pins in the row.

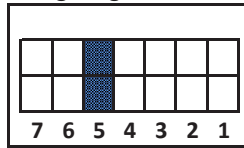

- » **Note that the Extended and Comfort Defrost settings can not be enabled at the same time.** This means there should not be jumpers on both rows 5 and 6.

5b) Slave mode

- » In Slave mode, an external device (e.g. air handler) or switch will dictate when the unit will operate.
- » By default, the Slave mode option is DISABLED.
- » To activate slave mode, position a jumper on row 7 and make sure it connects both pins in the row.

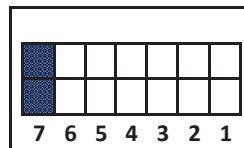

5c) Variable speed mode (0-10V mode)

- » The variable speed mode allows the unit to be operated at any speed from 0 to 10 VDC instead of discrete values. The maximum speed can be selected manually on the HRV/ERV during balancing (see Air Balancing, page 8).
- » By default, the 0-10V mode is DISABLED when there is no jumper on row 4.
- » To ENABLE the 0-10V mode, position a jumper on row 4 and make sure it connects both pins on the row.

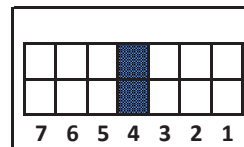

5d) Reduced speed mode

- » To allow the H/ERVs to fit a wider range of applications, the **low speed** setting for continuous ventilation may be reduced further (i.e. for a smaller space). Please refer to model specifications for airflow levels at the reduced speed.
- » By default, the reduced speed mode is DISABLED when there is no jumper on row 2.

- » To ENABLE the reduced speed mode, position a jumper on row 2 and make sure it connect both pins on the row.

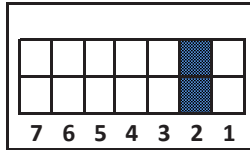

- Reverse the process above by reinstalling the circuit board cover, followed by the terminal block.

Here is a summary of the different options and how to configure the jumper pins to enable them:

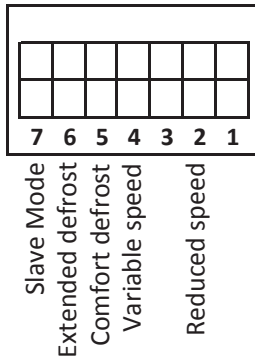

Unit Wiring for 0-10V Mode

With this new function, the unit can be controlled by external 0-10 VDC signals to provide continuously variable speeds and optimize IAQ and efficiency. It is possible to operate each blower independently, or to operate the blowers together with the same input.

Note: *The 0-10V Mode cannot be used with a wall timer (611228).*

To enable the 0-10V Mode with an input for each motor independently, connect your HRV/ERV as illustrated on the next page:

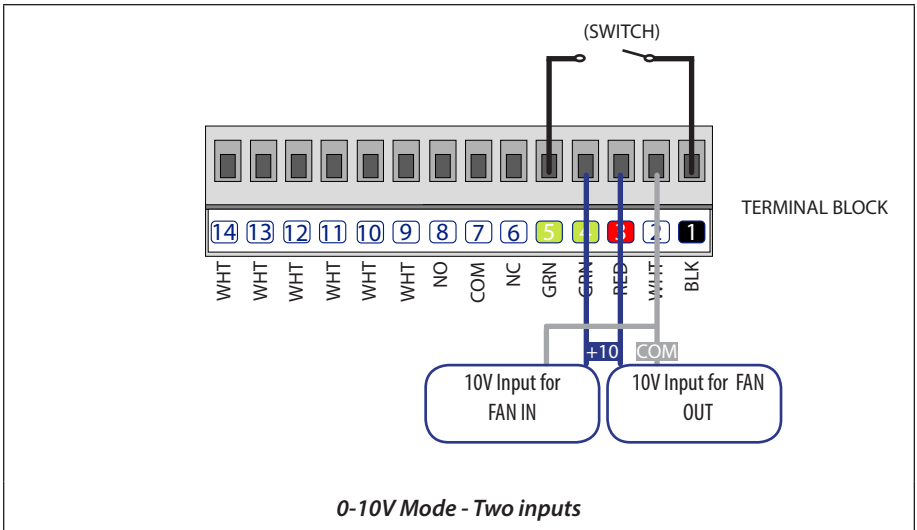

To enable the 0-10V Mode with only one input for both motors, connect your HRV/ERV as illustrated below:

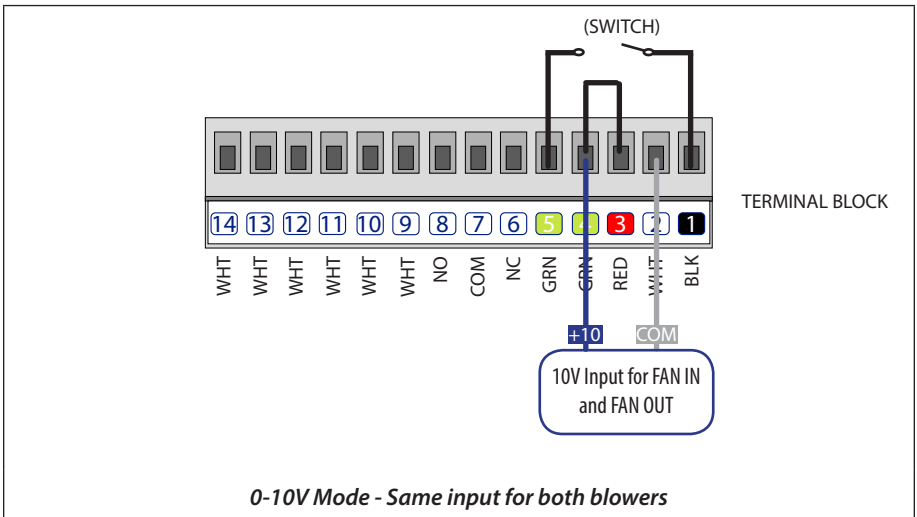

In both cases, the switch between the terminals 1 and 5 allows the user to choose between the manual and automatic modes. When the switch is off, the unit can be controlled manually, and the installer can calibrate the ventilation maximum speed (see Air Balancing, page 8).

When the switch is on, the 0-10V Mode is enabled. If the input signal is between 0V-0.5V, the blower is off. The blowers will run at variable speeds with inputs between 0.5V-9.5V, and will operate at maximum speed for inputs between 9.5V-10V.



American ALDES Ventilation Corporation
4521 19th St. Ct. E.
Suite 104
Bradenton, FL 34203
1-800-255-7749
www.aldes.us

Aldes Canada
100 Rue Carter
Saint-Leonard d'Aston, QC J0C 1M0
1-800-262-0916
www.aldes.ca